



>> DATA SHEET

(DOC No. HX8705-B-DS)

>> HX8705-B

800x600CH EPD Source+Gate
Driver

Preliminary version 01 June, 2010

1. General Description

The HX8705-B is a 800-channel outputs source driver and 600-channel outputs gate driver, which is used for driving the EPD panel. For source driver, it consists of a 800-bit long 2-bit wide shift register with 4-groups 2-bit wide input, a 800-bit long 2-bit wide latch, and a 800-channel 3 level-voltage driver. Each 2-bit wide data in the latch and the OE signal are decoded to 3 control signals. After level shifted, the control signals make the 3 level-voltage driver output VPOS, VNEG, or VSSA voltage. For gate driver, it is designed for 2-level gate output with 43V driving voltage range. The circuits are made of CMOS process, consuming low power.

2. Features

- | 3-level source output
- | 800 channel source outputs
- | Maximum 25MHz source driver operation frequency
- | Source driving voltage range: $\pm 16V$
- | 4-group 2-bit wide data input
- | 2-level gate output
- | 600 channel gate outputs
- | Maximum 200KHz gate driver operation frequency
- | Gate driving voltage range: 43V
- | Digital supply voltage: 2.7V to 3.6V
- | Bi-directional data shift capability
- | High voltage CMOS process technology
- | COG package

3. Block Diagram

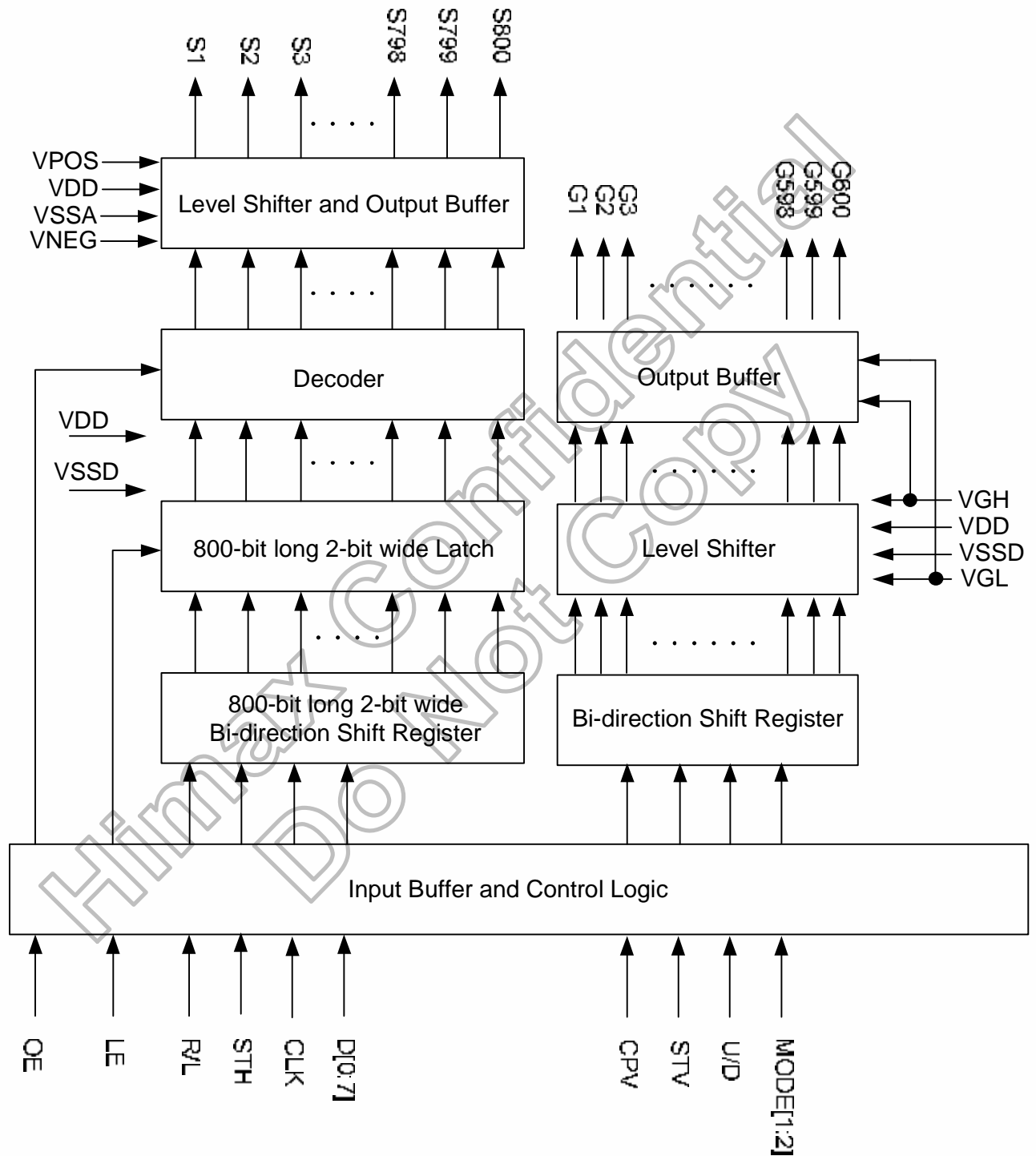

4. Pin Description

Pin name	I/O	Function	Description															
CLK	In	Shift clock input	The clock for the source driver internal shift registers. CLK senses start pulse and captures data D[0:7] at its rising edge. This pin is internally pull down.															
D[0:7]	In	Display data input	Shift register data input pins. These pins are pull down internally.															
R/L	In	Shift direction control pin	The shift direction of device internal shift register is controlled by this pin as shown below: R/L=H, S797~S800 are the first data output, S1~S4 are the 200 th data output R/L=L, S1~S4 are the first data output, S797~S800 are the 200 th data output. This pin is pull down internally.															
STH	In	Start pulse input pin	STH is used for start pulse input R/L=H, S797~S800 are the first data output, S1~S4 are the 200 th data output R/L=L, S1~S4 are the first data output, S797~S800 are the 200 th data output.															
LE	In	Latch enable	Load shift register data into the latch when LE is high. This pin is pull down internally.															
OE	In	Output enable	OE is asynchronous with CLK. When OE=H: Outputs are enabled. When OE=L: Outputs are forced to VSSA. This pin is pull down internally.															
S1~S800	Out	Source driver output	According to the data in the latch and OE level, the output voltage is one of VPOS, VSSA, or VNEG															
CPV	In	Shift clock input	The clock for the gate driver internal shift registers.															
U/D	In	Shift direction control pin	The shift direction of device internal shift register is controlled by this pin as shown below: U/D =H, STV→G1→G2→...→G600 U/D =L, STV→G600→...→G2→G1 This pin is pull down internally.															
STV	In	Start pulse Input pin	STV is used for start pulse input															
MODE2 MODE1	In	Gate output mode selection	Gate output mode selection <table border="1" style="width:100%; border-collapse: collapse;"> <thead> <tr> <th>Output mode</th> <th>MODE2</th> <th>MODE1</th> </tr> </thead> <tbody> <tr> <td>One pulse mode</td> <td>H</td> <td>H</td> </tr> <tr> <td>Continuous double pulse mode</td> <td>H</td> <td>L</td> </tr> <tr> <td>Jumping double pulse mode</td> <td>L</td> <td>H</td> </tr> <tr> <td>Fixed to VGL</td> <td>L</td> <td>L</td> </tr> </tbody> </table>	Output mode	MODE2	MODE1	One pulse mode	H	H	Continuous double pulse mode	H	L	Jumping double pulse mode	L	H	Fixed to VGL	L	L
Output mode	MODE2	MODE1																
One pulse mode	H	H																
Continuous double pulse mode	H	L																
Jumping double pulse mode	L	H																
Fixed to VGL	L	L																
G1~G600	Out	Driver output pins for driving gate electrode of EPD	The output voltage is either VGH or VGL for driving the gate electrode of EPD panel depending on the data stored in shift register and the state of CPV.															
VPOS	In	Power supply	Power supply for positive source drive output															
VNEG	In	Power supply	Power supply for negative source drive output															
VDD	In	Power supply	Logic power															
VSSD	In	Power supply	Logic ground															

Pin name	I/O	Function	Description
VSSA	In	Power supply	Analog ground for driver output. Don't short VSSA with VSSD by ITO on EPD panel. Connect it to VSSD on PCB or FPC.
VGH	In	Power supply	Power supply for gate drive output high
VGL	In	Power supply	Power supply for gate drive output low
TEST1		Test pin	Please keep this pin floating

Himax Confidential
Do Not Copy

5. Function Description

5.1 Device operation

5.1.1 Source Block operation

HX8705-B is a 800-channel outputs source driver used for driving the source electrodes of an EPD panel. It consists of a 800-bit long 2-bit wide shift register with 4-groups 2-bit wide input, a 800-bit long 2-bit wide latch, and a 800-channel 3 level-voltage driver. Each 2-bit wide data in the latch and the OE signal are decoded to 3 control signals. After level shifted, the control signals make the 3 level-voltage driver output VPOS, VNEG, or VSSA voltage

When R/L=H, the device start pulse input pin STH is sensed at CLK rising edge which makes the internal shift register enabled. At first CLK rising edge, first data D[0:7] stored in the 797st~800th latch circuit. When 200th CLK rising edge, data D[0:7] stored in the 1st~4th latch circuit.

LE controls the 800-bit long 2-bit wide latch. It loads the data in the shift register data into the latch when it is high, and the driver output starts to change its output according to the data in the latch.

R/L pin decides the shift direction of the shift register. When R/L is high, S797~S800 are the first data output,. When R/L is low, S1~S4 are the first data output. Chip enable pin OE is asynchronous to the clock CLK. When OE is high, outputs enabled. When OE is low, outputs forced to VSSA level. However, the data of the shift register is not cleared even if OE is low.

Each source driver output pin is switched to one of [VSSA, VPOS, VNEG] according to the data in the latch and OE level.

To maintain VNEG at a safe voltage when the supply is turned off, an external schottky diode from VNEG to VSSA may be required.

Driver Output Control

OE	D[2n+1]	D[2n]	OUT[n+1+4K]
H	L	L	VSSA
H	L	H	VPOS
H	H	L	VNEG
H	H	H	VSSA
L	X	X	VSSA

Note: n = 0 to 3, k = 0 to 199

Latch Block

LE	Data in 800-bit long 2-bit wide latch
H	Load data into latch from shifter register
L	Hold latch data

Shift Register Block

R/L = H	R/L = L
First data: D[1:0]-> S797 D[3:2]-> S798 D[5:4]-> S799 D[7:6]-> S800 200 th data: D[1:0]-> S1 D[3:2]-> S2 D[5:4]-> S3 D[7:6]-> S4	First data: D[1:0]-> S1 D[3:2]-> S2 D[5:4]-> S3 D[7:6]-> S4 200 th data: D[1:0]-> S797 D[3:2]-> S798 D[5:4]-> S799 D[7:6]-> S800

5.1.2 Gate Block operation

When U/D=H, the STV start pulse input is sensed on the rising edge of CPV and stored in the first stage of shift register at the 3rd/4th/5th rising edge of CPV which are corresponding to “jumping double pulse mode”, “continuous double pulse mode”, or “one pulse mode” respectively. The stored data is inverted and logic AND operation with CPV. Then, it is level shifted and output from the OUT1 pin. While stored data is transferred to the next stage shift register on the every rising edge of CPV, new data of STV is sensed simultaneously.

The output pin (G1 to G600) supplies VGH voltage or VGL voltage to the EPD panel depending on the data stored in the shift register and CPV level. For normal operation, a VGH voltage is outputted one by one from G1 to G600 in synchronization with CPV pulse.

Example of input/output timing (U/D=H, MODE2=H, MODE1=H)

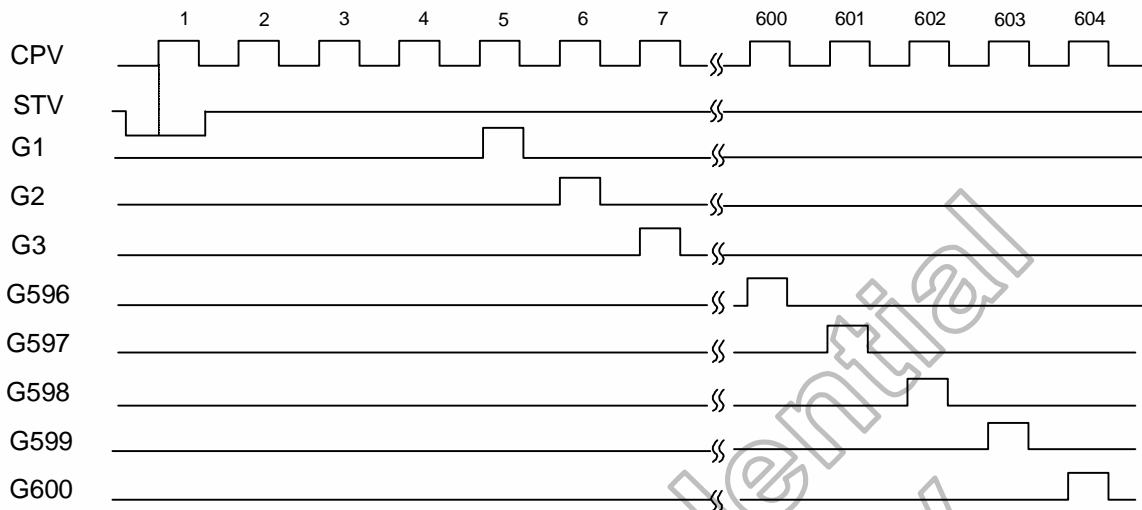

Example of input/output timing (U/D=L, MODE2=H, MODE1=H)

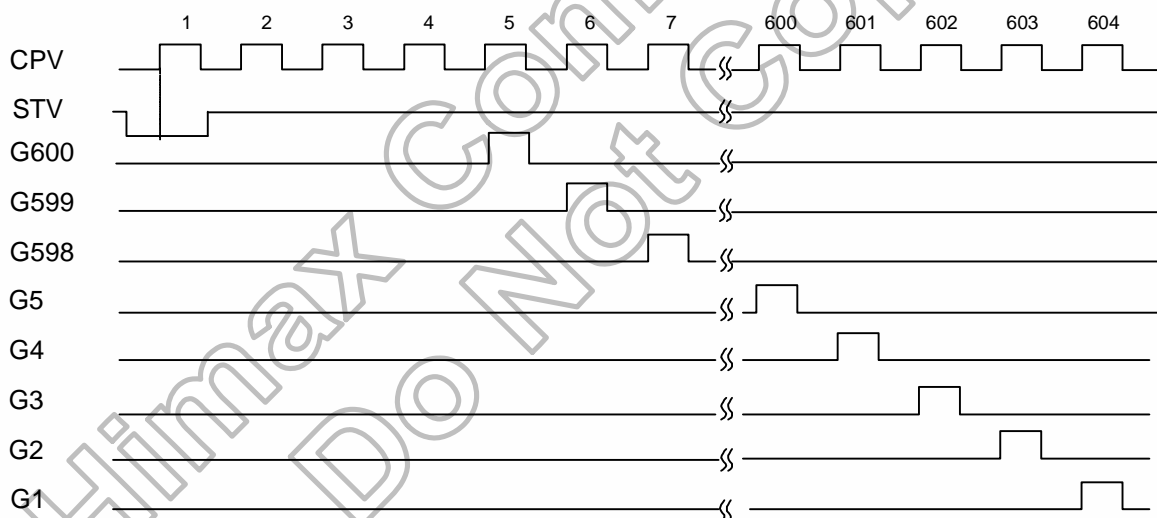

Example of input/output timing (U/D=H, MODE2= H, MODE1= L)

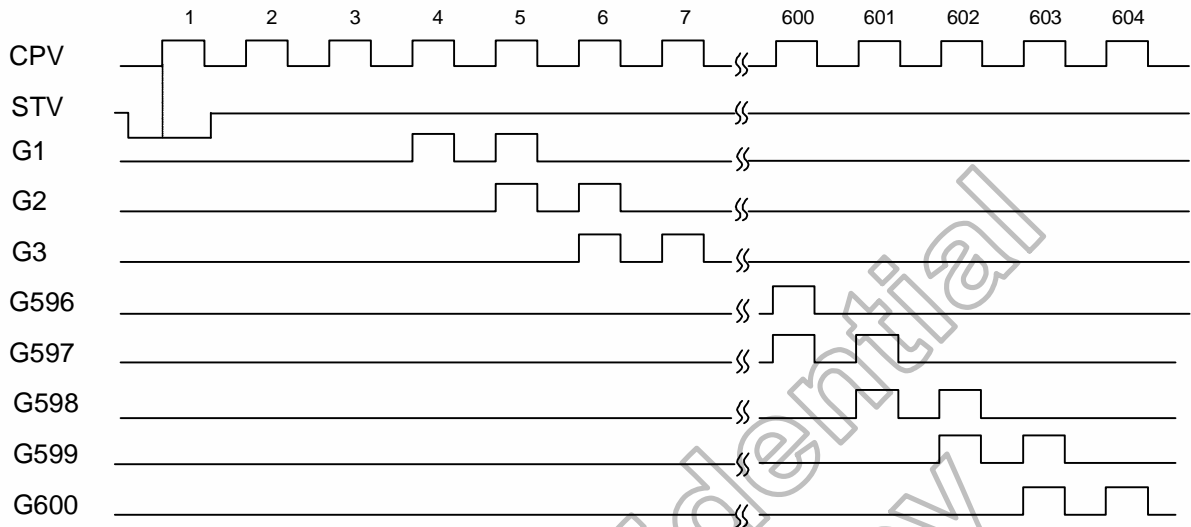

Example of input/output timing (U/D=L, MODE2=H, MODE1=L)

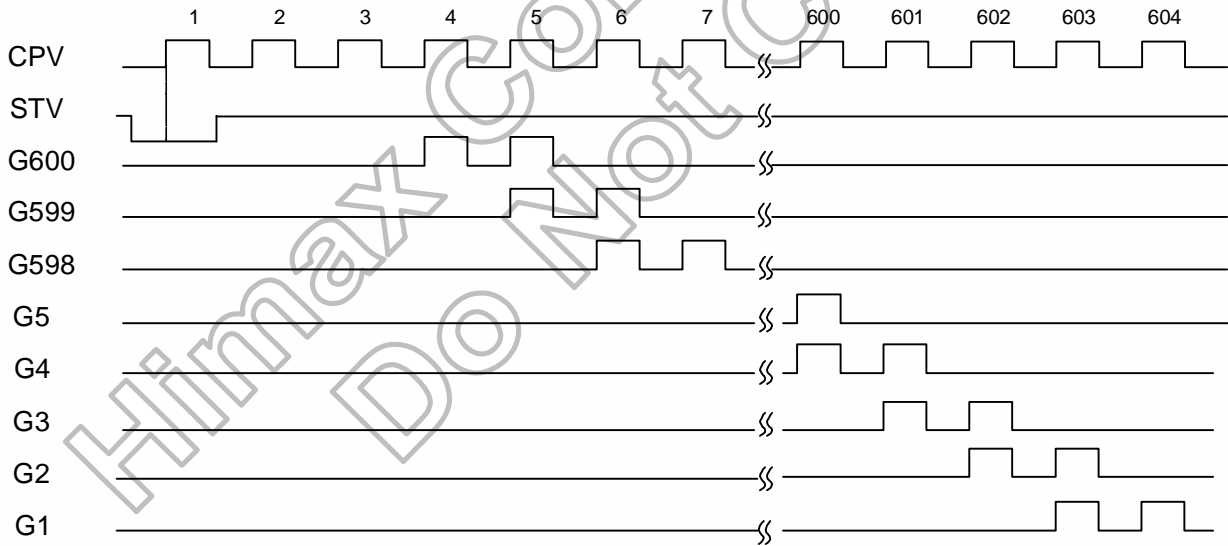

Example of input/output timing (U/D=H, MODE2=L, MODE1=H)

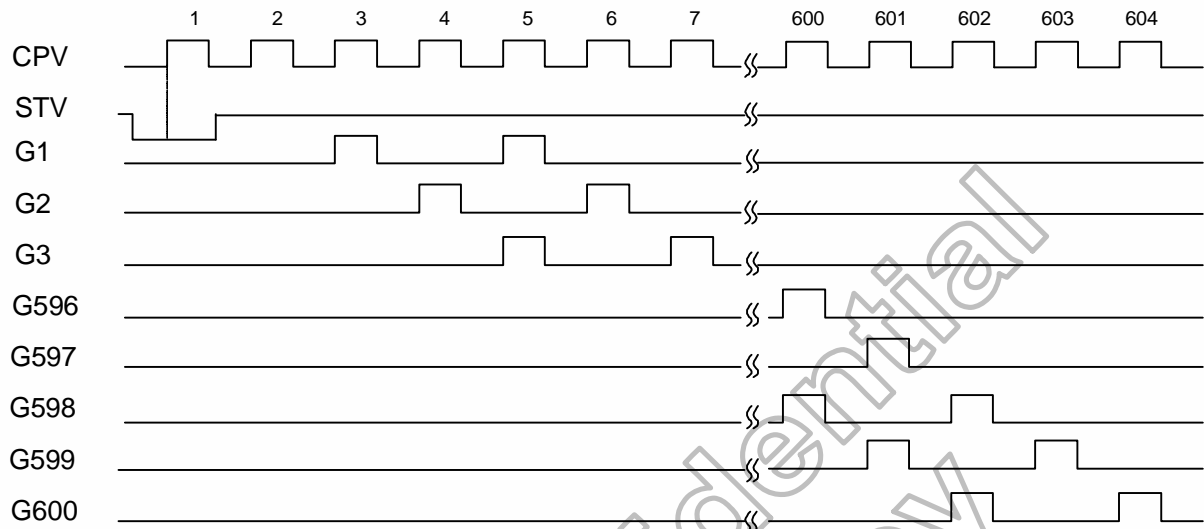

Example of input/output timing (U/D=L, MODE2=L, MODE1=H)

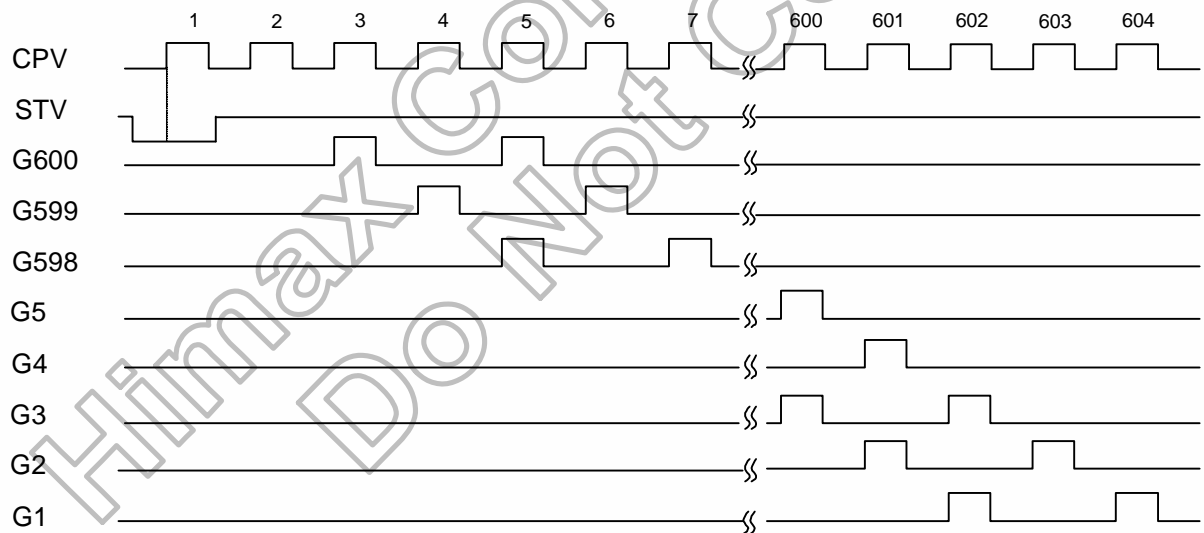

5.2 Power level

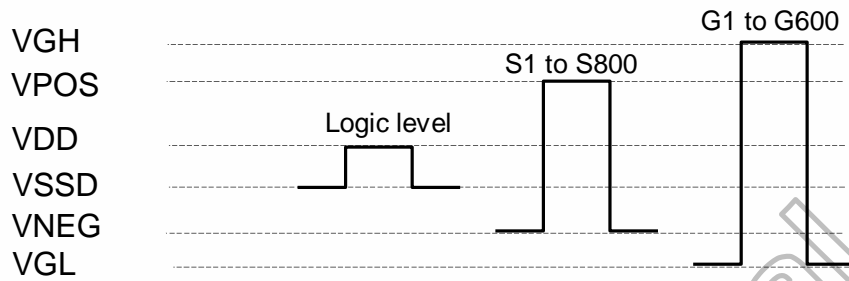

The logic levels of CLK, D[0:7], R/L, STH, LE, OE, CPV, U/D, MODE1, MODE2 and STV have to swing between VDD for “H” and VSSD for “L”.

5.3 Power on/off sequence

To prevent the device from damage due to latch up, the power on/off sequence shown below must be followed.

To avoid possible power off noise, below power off sequence must be followed. According to the RC loading of the display, an adequate delay time help to make sure that the display can discharge completely.

When power on: VDD=>VGL=> VNEG/VPOS/VGH=>OE
 When power off: OE=> VPOS/VGH/VNEG=> VGL=> VDD

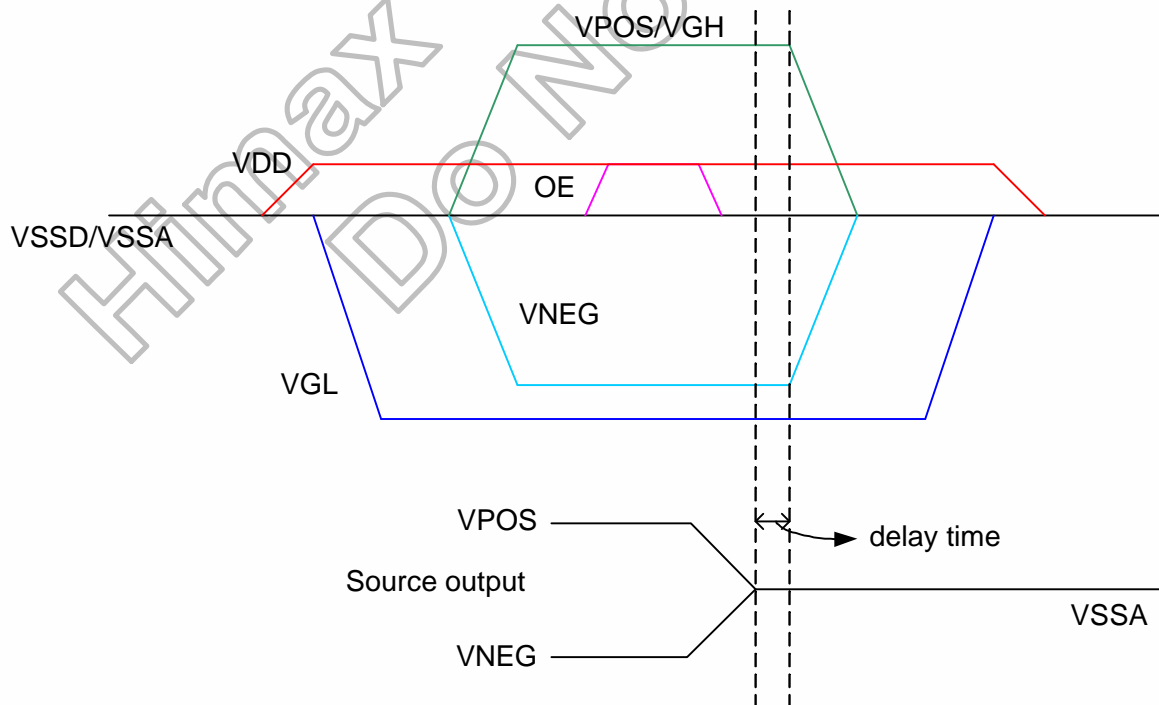

6. DC Characteristics

6.1 Absolute maximum rating (VSSD=VSSA=0V)

Parameter	Symbol	Spec.			Unit
		Min.	Typ.	Max.	
Power supply voltage 1	VPOS	-0.3	-	+20	V
Power supply voltage 2	VNEG	-20	-	+0.3	V
Power supply voltage 3	VGH	-0.3	-	+47.0	V
Power supply voltage 4	VDD	-0.3	-	+6.0	V
Power supply voltage 5	VGL	VGH-47	-	+0.3	V
Input voltage	V _{IN}	-0.3	-	VDD+0.3	V
Storage temperature	T _{STG}	-55	-	+125	°C

Note: Device will probably be damaged permanently in case that the stresses are over the absolute maximum ratings listed above.

6.2 Recommended operating conditions (VSSD=VSSA=0V)

Parameter	Symbol	Spec.			Unit
		Min.	Typ.	Max.	
Power supply voltage 1	VPOS	10	-	16	V
Power supply voltage 2	VNEG	-16	-	-10	V
Power supply voltage 3	VGH	10	-	VGL+43	V
Power supply voltage 4	VDD	2.7	3.3	3.6	V
Power supply voltage 5	VGL	-25	-	-10	V
Power supply voltage 6	VGH -VGL	12	-	43	V
Power supply voltage 7	VNEG -VGL	0	-	10	V
Operation frequency	F _{CLK}	-	-	25	MHz
Operation frequency	F _{CPV}	-	-	200	KHz
Operation temperature	T _A	-40	-	+85	°C

6.3 DC Electrical characteristics (VSSD=VSSA=0V)

(VDD=2.7~3.6V, VPOS=15V, VNEG=-15V, VGH=20V, VGL=-20V, TA=25°, VSSD=VSSA=0V)

Parameter	Symbol	Applicable pin	Condition	Spec.			Unit
				Min.	Typ.	Max.	
Input "H" voltage	V _{IH}	All input	-	0.7VDD	-	VDD	V
Input "L" voltage	V _{IL}	All input	-	0	-	0.3VDD	V
Input leakage current	I _{IN}	Note ⁽¹⁾	-	-1	-	1	μA
Pull low resistance	R _{PI}	Note ⁽²⁾	V _{IN} =VDD	40	-	200	kΩ
Output resistance	R _{ON}	S1~S800	VPOS=15V, VNEG=-15V, I _{OUT} =1mA	-	-	10	KΩ
Output H resistance	R _{ONH}	G1 ~ G600	V _{OUT} = VGH-0.5V	-	-	1000	Ω
Output L resistance	R _{ONL}	G1 ~ G600	V _{OUT} = VGL+0.5V	-	-	1000	Ω
VDD static current	I _{DD, static}	-	V _{IN} =0V	-	-	50	μA
VPOS static current	I _{POS, static}	-	V _{IN} =0V	-	-	20	μA
VNEG static current	I _{NEG, static}	-	V _{IN} =0V	-20	-	-	μA

Parameter	Symbol	Applicable pin	Condition	Spec.			Unit
				Min.	Typ.	Max.	
VDD operation current	$I_{DD, AC}$	-	VDD = 3V, F _{CLK} =20MHz, V _{IH} =VDD, V _{IL} =0	-	15	-	mA
VPOS operation current	$I_{POS, AC}$	-	C _{LOAD} =100pF, VPOS=15V, VNEG=-15V,	-	28	-	mA
VNEG operation current	$I_{NEG, AC}$	-	t _{LINE} =25us, DC VCOM	-	-28	-	mA
VGH operation current	$I_{VGH, AC}$	-	No load VDD = 3V, VGH=20V,	-	-	100	μA
VGL operation current	$I_{VDD, AC}$	-	VGL=-20V, F _{CPV} =50KHZ,	-100	-	-	

Note: (1) I_I input except for pull low pins
 (2) LK, D[0:7], R/L, LE, OE, U/D

Himax Confidential
Do Not Copy

7. AC Characteristics

Parameter	Symbol	Condition	Spec.			Unit
			Min.	Typ.	Max.	
CLK period	PW_{CLK}	-	40	-	-	ns
CLK pulse width	PW_{CLKH} , PW_{CLKL}	-	10	-	-	ns
D[0:7], STH setup time	t_{SU1}	-	8	-	-	ns
D[0:7], STH hold time	t_{HD1}	-	8	-	-	ns
LE high-level pulse width	PW_{LE}	-	40	-	-	ns
LE on delay time	t_{PD1}	-	40	-	-	ns
LE off delay time	t_{PD2}	-	200	-	-	ns
R/L setup time	t_{SU2}	-	100	-	-	ns
R/L hold time	t_{HD2}	-	100	-	-	ns
Output settle time to $\pm 30mV$	t_{OUT}	$C_{LOAD}=50pF$	-	-	14	us
CPV period	t_{CPV}	-	5	-	-	μs
CPV pulse width	t_{CPVH} , t_{CPVL}	50% duty cycle	0.5	-	-	μs
STV setup time	t_{SU3}	-	0.1	-	-	μs
STV hold time	t_{HD3}	-	0.3	-	-	μs
CPV to output delay time	t_{PD3}	$CL=300pF$	-	-	1	μs

Note: The measurement point for all of above signals is at 50% of input/output amplitude.

$V_{DD}=2.7V\sim 3.6V$, $V_{POS}=15V$, $V_{NEG}=-15V$, $V_{GH}=20V$, $V_{GL}=-10V$, $V_{SSD}=V_{SSA}=0V$, $T_A=25^\circ C$,

8. Waveform

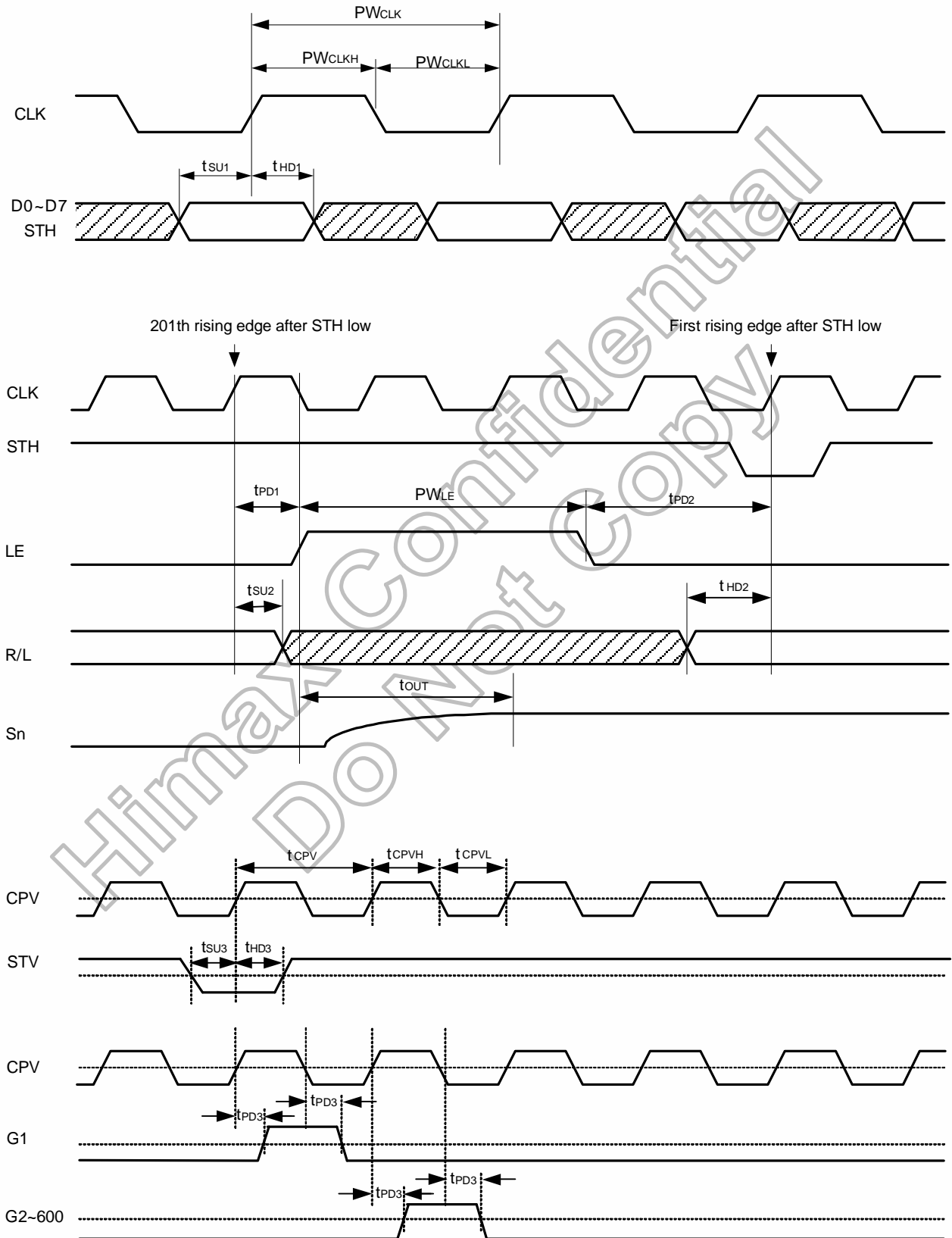

9. Pad Coordinates

9.1 HX8705-B bump location & outline dimensions

Chip size: 21702µm x 1112µm (scribe line included)
 Output pitch: 15µm
 Scribe line: 80µm
 Bump height: 15 ±3µm
 Bump hardness: 60HV ± 15HV

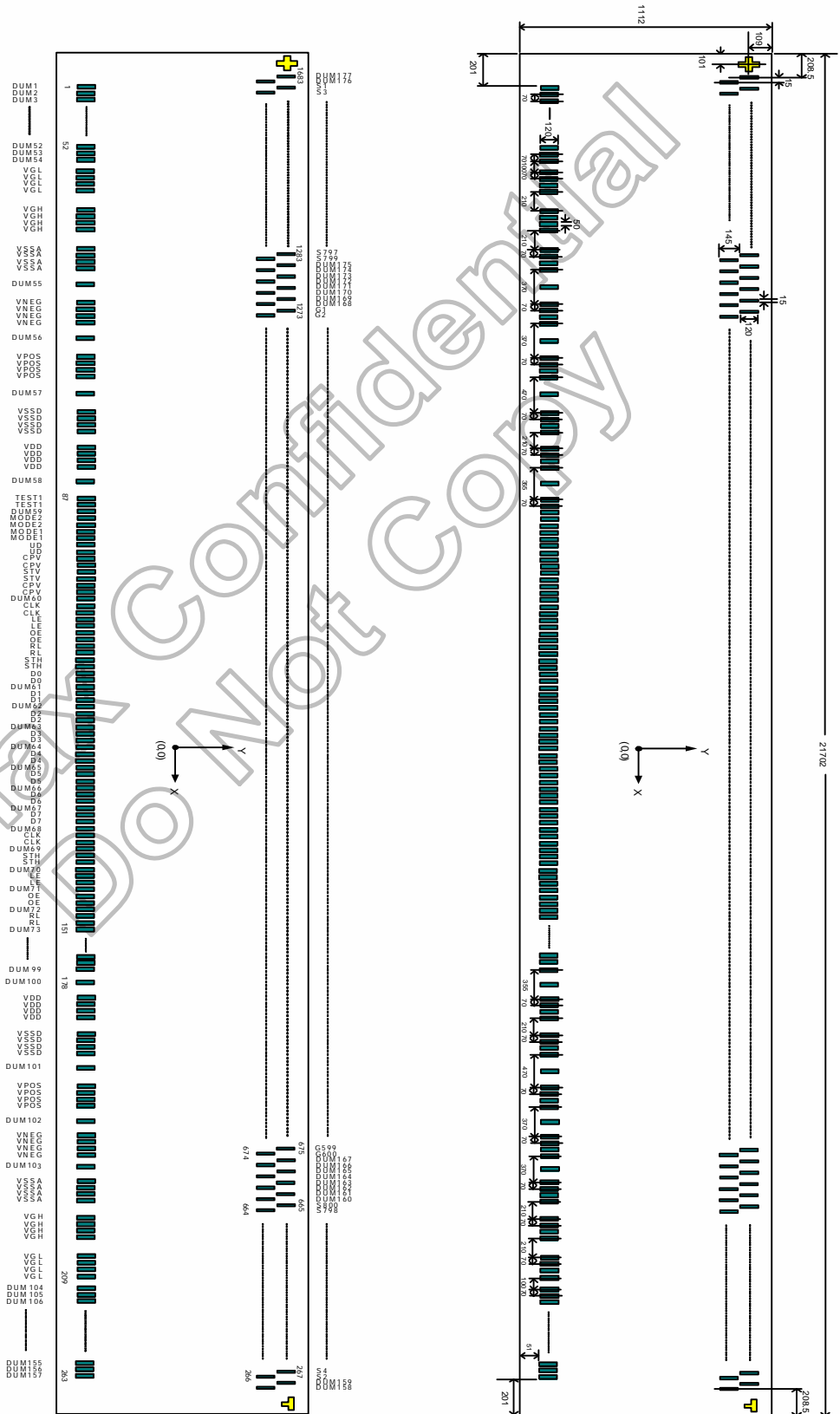

9.2 Alignment mark

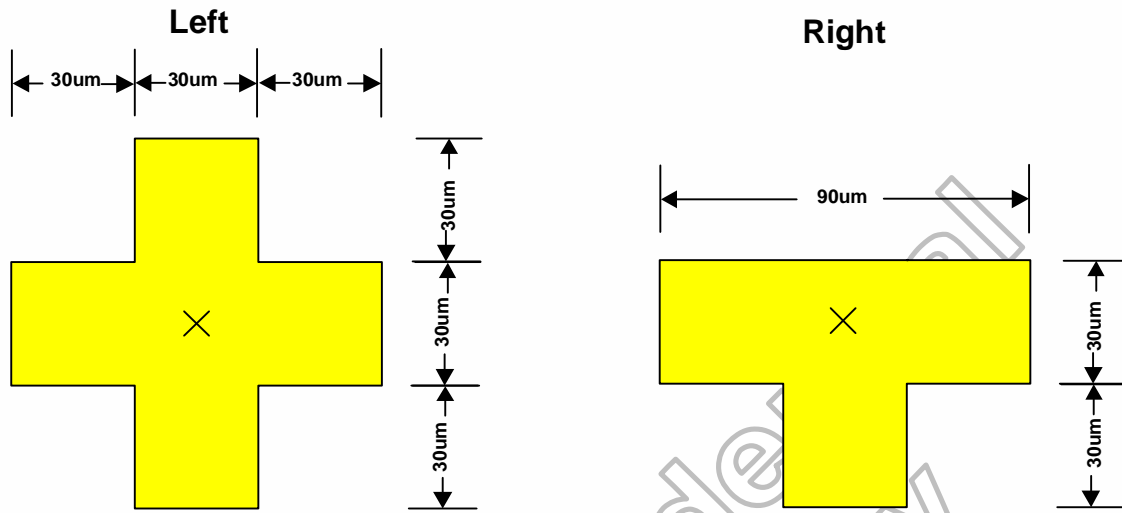

9.3 Bump center coordinates

No.	Name	X	Y	Bump size(μm)
1	DUM1	-10625	-445	50X120
2	DUM2	-10555	-445	50X120
3	DUM3	-10485	-445	50X120
4	DUM4	-10415	-445	50X120
5	DUM5	-10345	-445	50X120
6	DUM6	-10275	-445	50X120
7	DUM7	-10205	-445	50X120
8	DUM8	-10135	-445	50X120
9	DUM9	-10065	-445	50X120
10	DUM10	-9995	-445	50X120
11	DUM11	-9925	-445	50X120
12	DUM12	-9855	-445	50X120
13	DUM13	-9785	-445	50X120
14	DUM14	-9715	-445	50X120
15	DUM15	-9645	-445	50X120
16	DUM16	-9575	-445	50X120
17	DUM17	-9505	-445	50X120
18	DUM18	-9435	-445	50X120
19	DUM19	-9365	-445	50X120
20	DUM20	-9295	-445	50X120
21	DUM21	-9225	-445	50X120
22	DUM22	-9155	-445	50X120
23	DUM23	-9085	-445	50X120
24	DUM24	-9015	-445	50X120
25	DUM25	-8945	-445	50X120
26	DUM26	-8875	-445	50X120
27	DUM27	-8805	-445	50X120
28	DUM28	-8735	-445	50X120
29	DUM29	-8665	-445	50X120
30	DUM30	-8595	-445	50X120
31	DUM31	-8525	-445	50X120
32	DUM32	-8455	-445	50X120
33	DUM33	-8385	-445	50X120
34	DUM34	-8315	-445	50X120
35	DUM35	-8245	-445	50X120
36	DUM36	-8175	-445	50X120
37	DUM37	-8105	-445	50X120
38	DUM38	-8035	-445	50X120
39	DUM39	-7965	-445	50X120
40	DUM40	-7895	-445	50X120
41	DUM41	-7825	-445	50X120
42	DUM42	-7755	-445	50X120
43	DUM43	-7685	-445	50X120
44	DUM44	-7615	-445	50X120
45	DUM45	-7545	-445	50X120
46	DUM46	-7475	-445	50X120
47	DUM47	-7405	-445	50X120
48	DUM48	-7335	-445	50X120
49	DUM49	-7265	-445	50X120
50	DUM50	-7195	-445	50X120
51	DUM51	-7125	-445	50X120
52	DUM52	-7055	-445	50X120
53	DUM53	-6985	-445	50X120
54	DUM54	-6915	-445	50X120
55	VGL	-6815	-445	50X120
56	VGL	-6745	-445	50X120
57	VGL	-6675	-445	50X120
58	VGL	-6605	-445	50X120
59	VGH	-6395	-445	50X120
60	VGH	-6325	-445	50X120

No.	Name	X	Y	Bump size(μm)
61	VGH	-6255	-445	50X120
62	VGH	-6185	-445	50X120
63	VSSA	-5975	-445	50X120
64	VSSA	-5905	-445	50X120
65	VSSA	-5835	-445	50X120
66	VSSA	-5765	-445	50X120
67	DUM55	-5580	-445	50X120
68	VNEG	-5395	-445	50X120
69	VNEG	-5325	-445	50X120
70	VNEG	-5255	-445	50X120
71	VNEG	-5185	-445	50X120
72	DUM56	-5000	-445	50X120
73	VPOS	-4815	-445	50X120
74	VPOS	-4745	-445	50X120
75	VPOS	-4675	-445	50X120
76	VPOS	-4605	-445	50X120
77	DUM57	-4370	-445	50X120
78	VSSD	-4135	-445	50X120
79	VSSD	-4065	-445	50X120
80	VSSD	-3995	-445	50X120
81	VSSD	-3925	-445	50X120
82	VDD	-3715	-445	50X120
83	VDD	-3645	-445	50X120
84	VDD	-3575	-445	50X120
85	VDD	-3505	-445	50X120
86	DUM58	-3327.5	-445	50X120
87	TEST1	-3150	-445	50X120
88	TEST1	-3080	-445	50X120
89	DUM59	-3010	-445	50X120
90	MODE2	-2940	-445	50X120
91	MODE2	-2870	-445	50X120
92	MODE1	-2800	-445	50X120
93	MODE1	-2730	-445	50X120
94	UD	-2660	-445	50X120
95	UD	-2590	-445	50X120
96	CPV	-2520	-445	50X120
97	CPV	-2450	-445	50X120
98	STV	-2380	-445	50X120
99	STV	-2310	-445	50X120
100	CPV	-2240	-445	50X120
101	CPV	-2170	-445	50X120
102	DUM60	-2100	-445	50X120
103	CLK	-2030	-445	50X120
104	CLK	-1960	-445	50X120
105	LE	-1890	-445	50X120
106	LE	-1820	-445	50X120
107	OE	-1750	-445	50X120
108	OE	-1680	-445	50X120
109	RL	-1610	-445	50X120
110	RL	-1540	-445	50X120
111	STH	-1470	-445	50X120
112	STH	-1400	-445	50X120
113	D0	-1330	-445	50X120
114	D0	-1260	-445	50X120
115	DUM61	-1190	-445	50X120
116	D1	-1120	-445	50X120
117	D1	-1050	-445	50X120
118	DUM62	-980	-445	50X120
119	D2	-910	-445	50X120
120	D2	-840	-445	50X120

No.	Name	X	Y	Bump size(μm)
121	DUM63	-770	-445	50X120
122	D3	-700	-445	50X120
123	D3	-630	-445	50X120
124	DUM64	-560	-445	50X120
125	D4	-490	-445	50X120
126	D4	-420	-445	50X120
127	DUM65	-350	-445	50X120
128	D5	-280	-445	50X120
129	D5	-210	-445	50X120
130	DUM66	-140	-445	50X120
131	D6	-70	-445	50X120
132	D6	0	-445	50X120
133	DUM67	70	-445	50X120
134	D7	140	-445	50X120
135	D7	210	-445	50X120
136	DUM68	280	-445	50X120
137	CLK	350	-445	50X120
138	CLK	420	-445	50X120
139	DUM69	490	-445	50X120
140	STH	560	-445	50X120
141	STH	630	-445	50X120
142	DUM70	700	-445	50X120
143	LE	770	-445	50X120
144	LE	840	-445	50X120
145	DUM71	910	-445	50X120
146	OE	980	-445	50X120
147	OE	1050	-445	50X120
148	DUM72	1120	-445	50X120
149	RL	1190	-445	50X120
150	RL	1260	-445	50X120
151	DUM73	1330	-445	50X120
152	DUM74	1400	-445	50X120
153	DUM75	1470	-445	50X120
154	DUM76	1540	-445	50X120
155	DUM77	1610	-445	50X120
156	DUM78	1680	-445	50X120
157	DUM79	1750	-445	50X120
158	DUM80	1820	-445	50X120
159	DUM81	1890	-445	50X120
160	DUM82	1960	-445	50X120
161	DUM83	2030	-445	50X120
162	DUM84	2100	-445	50X120
163	DUM85	2170	-445	50X120
164	DUM86	2240	-445	50X120
165	DUM87	2310	-445	50X120
166	DUM88	2380	-445	50X120
167	DUM89	2450	-445	50X120
168	DUM90	2520	-445	50X120
169	DUM91	2590	-445	50X120
170	DUM92	2660	-445	50X120
171	DUM93	2730	-445	50X120
172	DUM94	2800	-445	50X120
173	DUM95	2870	-445	50X120
174	DUM96	2940	-445	50X120
175	DUM97	3010	-445	50X120
176	DUM98	3080	-445	50X120
177	DUM99	3150	-445	50X120
178	DUM100	3327.5	-445	50X120
179	VDD	3505	-445	50X120
180	VDD	3575	-445	50X120

No.	Name	X	Y	Bump size(μm)
181	VDD	3645	-445	50X120
182	VDD	3715	-445	50X120
183	VSSD	3925	-445	50X120
184	VSSD	3995	-445	50X120
185	VSSD	4065	-445	50X120
186	VSSD	4135	-445	50X120
187	DUM101	4370	-445	50X120
188	VPOS	4605	-445	50X120
189	VPOS	4675	-445	50X120
190	VPOS	4745	-445	50X120
191	VPOS	4815	-445	50X120
192	DUM102	5000	-445	50X120
193	VNEG	5185	-445	50X120
194	VNEG	5255	-445	50X120
195	VNEG	5325	-445	50X120
196	VNEG	5395	-445	50X120
197	DUM103	5580	-445	50X120
198	VSSA	5765	-445	50X120
199	VSSA	5835	-445	50X120
200	VSSA	5905	-445	50X120
201	VSSA	5975	-445	50X120
202	VGH	6185	-445	50X120
203	VGH	6255	-445	50X120
204	VGH	6325	-445	50X120
205	VGH	6395	-445	50X120
206	VGL	6605	-445	50X120
207	VGL	6675	-445	50X120
208	VGL	6745	-445	50X120
209	VGL	6815	-445	50X120
210	DUM104	6915	-445	50X120
211	DUM105	6985	-445	50X120
212	DUM106	7055	-445	50X120
213	DUM107	7125	-445	50X120
214	DUM108	7195	-445	50X120
215	DUM109	7265	-445	50X120
216	DUM110	7335	-445	50X120
217	DUM111	7405	-445	50X120
218	DUM112	7475	-445	50X120
219	DUM113	7545	-445	50X120
220	DUM114	7615	-445	50X120
221	DUM115	7685	-445	50X120
222	DUM116	7755	-445	50X120
223	DUM117	7825	-445	50X120
224	DUM118	7895	-445	50X120
225	DUM119	7965	-445	50X120
226	DUM120	8035	-445	50X120
227	DUM121	8105	-445	50X120
228	DUM122	8175	-445	50X120
229	DUM123	8245	-445	50X120
230	DUM124	8315	-445	50X120
231	DUM125	8385	-445	50X120
232	DUM126	8455	-445	50X120
233	DUM127	8525	-445	50X120
234	DUM128	8595	-445	50X120
235	DUM129	8665	-445	50X120
236	DUM130	8735	-445	50X120
237	DUM131	8805	-445	50X120
238	DUM132	8875	-445	50X120
239	DUM133	8945	-445	50X120
240	DUM134	9015	-445	50X120

No.	Name	X	Y	Bump size(μm)
241	DUM135	9085	-445	50X120
242	DUM136	9155	-445	50X120
243	DUM137	9225	-445	50X120
244	DUM138	9295	-445	50X120
245	DUM139	9365	-445	50X120
246	DUM140	9435	-445	50X120
247	DUM1341	9505	-445	50X120
248	DUM142	9575	-445	50X120
249	DUM143	9645	-445	50X120
250	DUM144	9715	-445	50X120
251	DUM145	9785	-445	50X120
252	DUM146	9855	-445	50X120
253	DUM147	9925	-445	50X120
254	DUM148	9995	-445	50X120
255	DUM149	10065	-445	50X120
256	DUM150	10135	-445	50X120
257	DUM151	10205	-445	50X120
258	DUM152	10275	-445	50X120
259	DUM153	10345	-445	50X120
260	DUM154	10415	-445	50X120
261	DUM155	10485	-445	50X120
262	DUM156	10555	-445	50X120
263	DUM157	10625	-445	50X120
264	DUM158	10642.5	300	15X120
265	DUM159	10627.5	445	15X120
266	S2	10612.5	300	15X120
267	S4	10597.5	445	15X120
268	S6	10582.5	300	15X120
269	S8	10567.5	445	15X120
270	S10	10552.5	300	15X120
271	S12	10537.5	445	15X120
272	S14	10522.5	300	15X120
273	S16	10507.5	445	15X120
274	S18	10492.5	300	15X120
275	S20	10477.5	445	15X120
276	S22	10462.5	300	15X120
277	S24	10447.5	445	15X120
278	S26	10432.5	300	15X120
279	S28	10417.5	445	15X120
280	S30	10402.5	300	15X120
281	S32	10387.5	445	15X120
282	S34	10372.5	300	15X120
283	S36	10357.5	445	15X120
284	S38	10342.5	300	15X120
285	S40	10327.5	445	15X120
286	S42	10312.5	300	15X120
287	S44	10297.5	445	15X120
288	S46	10282.5	300	15X120
289	S48	10267.5	445	15X120
290	S50	10252.5	300	15X120
291	S52	10237.5	445	15X120
292	S54	10222.5	300	15X120
293	S56	10207.5	445	15X120
294	S58	10192.5	300	15X120
295	S60	10177.5	445	15X120
296	S62	10162.5	300	15X120
297	S64	10147.5	445	15X120
298	S66	10132.5	300	15X120
299	S68	10117.5	445	15X120
300	S70	10102.5	300	15X120

No.	Name	X	Y	Bump size(μm)
301	S72	10087.5	445	15X120
302	S74	10072.5	300	15X120
303	S76	10057.5	445	15X120
304	S78	10042.5	300	15X120
305	S80	10027.5	445	15X120
306	S82	10012.5	300	15X120
307	S84	9997.5	445	15X120
308	S86	9982.5	300	15X120
309	S88	9967.5	445	15X120
310	S90	9952.5	300	15X120
311	S92	9937.5	445	15X120
312	S94	9922.5	300	15X120
313	S96	9907.5	445	15X120
314	S98	9892.5	300	15X120
315	S100	9877.5	445	15X120
316	S102	9862.5	300	15X120
317	S104	9847.5	445	15X120
318	S106	9832.5	300	15X120
319	S108	9817.5	445	15X120
320	S110	9802.5	300	15X120
321	S112	9787.5	445	15X120
322	S114	9772.5	300	15X120
323	S116	9757.5	445	15X120
324	S118	9742.5	300	15X120
325	S120	9727.5	445	15X120
326	S122	9712.5	300	15X120
327	S124	9697.5	445	15X120
328	S126	9682.5	300	15X120
329	S128	9667.5	445	15X120
330	S130	9652.5	300	15X120
331	S132	9637.5	445	15X120
332	S134	9622.5	300	15X120
333	S136	9607.5	445	15X120
334	S138	9592.5	300	15X120
335	S140	9577.5	445	15X120
336	S142	9562.5	300	15X120
337	S144	9547.5	445	15X120
338	S146	9532.5	300	15X120
339	S148	9517.5	445	15X120
340	S150	9502.5	300	15X120
341	S152	9487.5	445	15X120
342	S154	9472.5	300	15X120
343	S156	9457.5	445	15X120
344	S158	9442.5	300	15X120
345	S160	9427.5	445	15X120
346	S162	9412.5	300	15X120
347	S164	9397.5	445	15X120
348	S166	9382.5	300	15X120
349	S168	9367.5	445	15X120
350	S170	9352.5	300	15X120
351	S172	9337.5	445	15X120
352	S174	9322.5	300	15X120
353	S176	9307.5	445	15X120
354	S178	9292.5	300	15X120
355	S180	9277.5	445	15X120
356	S182	9262.5	300	15X120
357	S184	9247.5	445	15X120
358	S186	9232.5	300	15X120
359	S188	9217.5	445	15X120
360	S190	9202.5	300	15X120

No.	Name	X	Y	Bump size(μm)
361	S192	9187.5	445	15X120
362	S194	9172.5	300	15X120
363	S196	9157.5	445	15X120
364	S198	9142.5	300	15X120
365	S200	9127.5	445	15X120
366	S202	9112.5	300	15X120
367	S204	9097.5	445	15X120
368	S206	9082.5	300	15X120
369	S208	9067.5	445	15X120
370	S210	9052.5	300	15X120
371	S212	9037.5	445	15X120
372	S214	9022.5	300	15X120
373	S216	9007.5	445	15X120
374	S218	8992.5	300	15X120
375	S220	8977.5	445	15X120
376	S222	8962.5	300	15X120
377	S224	8947.5	445	15X120
378	S226	8932.5	300	15X120
379	S228	8917.5	445	15X120
380	S230	8902.5	300	15X120
381	S232	8887.5	445	15X120
382	S234	8872.5	300	15X120
383	S236	8857.5	445	15X120
384	S238	8842.5	300	15X120
385	S240	8827.5	445	15X120
386	S242	8812.5	300	15X120
387	S244	8797.5	445	15X120
388	S246	8782.5	300	15X120
389	S248	8767.5	445	15X120
390	S250	8752.5	300	15X120
391	S252	8737.5	445	15X120
392	S254	8722.5	300	15X120
393	S256	8707.5	445	15X120
394	S258	8692.5	300	15X120
395	S260	8677.5	445	15X120
396	S262	8662.5	300	15X120
397	S264	8647.5	445	15X120
398	S266	8632.5	300	15X120
399	S268	8617.5	445	15X120
400	S270	8602.5	300	15X120
401	S272	8587.5	445	15X120
402	S274	8572.5	300	15X120
403	S276	8557.5	445	15X120
404	S278	8542.5	300	15X120
405	S280	8527.5	445	15X120
406	S282	8512.5	300	15X120
407	S284	8497.5	445	15X120
408	S286	8482.5	300	15X120
409	S288	8467.5	445	15X120
410	S290	8452.5	300	15X120
411	S292	8437.5	445	15X120
412	S294	8422.5	300	15X120
413	S296	8407.5	445	15X120
414	S298	8392.5	300	15X120
415	S300	8377.5	445	15X120
416	S302	8362.5	300	15X120
417	S304	8347.5	445	15X120
418	S306	8332.5	300	15X120
419	S308	8317.5	445	15X120
420	S310	8302.5	300	15X120

No.	Name	X	Y	Bump size(μm)
421	S312	8287.5	445	15X120
422	S314	8272.5	300	15X120
423	S316	8257.5	445	15X120
424	S318	8242.5	300	15X120
425	S320	8227.5	445	15X120
426	S322	8212.5	300	15X120
427	S324	8197.5	445	15X120
428	S326	8182.5	300	15X120
429	S328	8167.5	445	15X120
430	S330	8152.5	300	15X120
431	S332	8137.5	445	15X120
432	S334	8122.5	300	15X120
433	S336	8107.5	445	15X120
434	S338	8092.5	300	15X120
435	S340	8077.5	445	15X120
436	S342	8062.5	300	15X120
437	S344	8047.5	445	15X120
438	S346	8032.5	300	15X120
439	S348	8017.5	445	15X120
440	S350	8002.5	300	15X120
441	S352	7987.5	445	15X120
442	S354	7972.5	300	15X120
443	S356	7957.5	445	15X120
444	S358	7942.5	300	15X120
445	S360	7927.5	445	15X120
446	S362	7912.5	300	15X120
447	S364	7897.5	445	15X120
448	S366	7882.5	300	15X120
449	S368	7867.5	445	15X120
450	S370	7852.5	300	15X120
451	S372	7837.5	445	15X120
452	S374	7822.5	300	15X120
453	S376	7807.5	445	15X120
454	S378	7792.5	300	15X120
455	S380	7777.5	445	15X120
456	S382	7762.5	300	15X120
457	S384	7747.5	445	15X120
458	S386	7732.5	300	15X120
459	S388	7717.5	445	15X120
460	S390	7702.5	300	15X120
461	S392	7687.5	445	15X120
462	S394	7672.5	300	15X120
463	S396	7657.5	445	15X120
464	S398	7642.5	300	15X120
465	S400	7627.5	445	15X120
466	S402	7612.5	300	15X120
467	S404	7597.5	445	15X120
468	S406	7582.5	300	15X120
469	S408	7567.5	445	15X120
470	S410	7552.5	300	15X120
471	S412	7537.5	445	15X120
472	S414	7522.5	300	15X120
473	S416	7507.5	445	15X120
474	S418	7492.5	300	15X120
475	S420	7477.5	445	15X120
476	S422	7462.5	300	15X120
477	S424	7447.5	445	15X120
478	S426	7432.5	300	15X120
479	S428	7417.5	445	15X120
480	S430	7402.5	300	15X120

No.	Name	X	Y	Bump size(μm)
481	S432	7387.5	445	15X120
482	S434	7372.5	300	15X120
483	S436	7357.5	445	15X120
484	S438	7342.5	300	15X120
485	S440	7327.5	445	15X120
486	S442	7312.5	300	15X120
487	S444	7297.5	445	15X120
488	S446	7282.5	300	15X120
489	S448	7267.5	445	15X120
490	S450	7252.5	300	15X120
491	S452	7237.5	445	15X120
492	S454	7222.5	300	15X120
493	S456	7207.5	445	15X120
494	S458	7192.5	300	15X120
495	S460	7177.5	445	15X120
496	S462	7162.5	300	15X120
497	S464	7147.5	445	15X120
498	S466	7132.5	300	15X120
499	S468	7117.5	445	15X120
500	S470	7102.5	300	15X120
501	S472	7087.5	445	15X120
502	S474	7072.5	300	15X120
503	S476	7057.5	445	15X120
504	S478	7042.5	300	15X120
505	S480	7027.5	445	15X120
506	S482	7012.5	300	15X120
507	S484	6997.5	445	15X120
508	S486	6982.5	300	15X120
509	S488	6967.5	445	15X120
510	S490	6952.5	300	15X120
511	S492	6937.5	445	15X120
512	S494	6922.5	300	15X120
513	S496	6907.5	445	15X120
514	S498	6892.5	300	15X120
515	S500	6877.5	445	15X120
516	S502	6862.5	300	15X120
517	S504	6847.5	445	15X120
518	S506	6832.5	300	15X120
519	S508	6817.5	445	15X120
520	S510	6802.5	300	15X120
521	S512	6787.5	445	15X120
522	S514	6772.5	300	15X120
523	S516	6757.5	445	15X120
524	S518	6742.5	300	15X120
525	S520	6727.5	445	15X120
526	S522	6712.5	300	15X120
527	S524	6697.5	445	15X120
528	S526	6682.5	300	15X120
529	S528	6667.5	445	15X120
530	S530	6652.5	300	15X120
531	S532	6637.5	445	15X120
532	S534	6622.5	300	15X120
533	S536	6607.5	445	15X120
534	S538	6592.5	300	15X120
535	S540	6577.5	445	15X120
536	S542	6562.5	300	15X120
537	S544	6547.5	445	15X120
538	S546	6532.5	300	15X120
539	S548	6517.5	445	15X120
540	S550	6502.5	300	15X120

No.	Name	X	Y	Bump size(μm)
541	S552	6487.5	445	15X120
542	S554	6472.5	300	15X120
543	S556	6457.5	445	15X120
544	S558	6442.5	300	15X120
545	S560	6427.5	445	15X120
546	S562	6412.5	300	15X120
547	S564	6397.5	445	15X120
548	S566	6382.5	300	15X120
549	S568	6367.5	445	15X120
550	S570	6352.5	300	15X120
551	S572	6337.5	445	15X120
552	S574	6322.5	300	15X120
553	S576	6307.5	445	15X120
554	S578	6292.5	300	15X120
555	S580	6277.5	445	15X120
556	S582	6262.5	300	15X120
557	S584	6247.5	445	15X120
558	S586	6232.5	300	15X120
559	S588	6217.5	445	15X120
560	S590	6202.5	300	15X120
561	S592	6187.5	445	15X120
562	S594	6172.5	300	15X120
563	S596	6157.5	445	15X120
564	S598	6142.5	300	15X120
565	S600	6127.5	445	15X120
566	S602	6112.5	300	15X120
567	S604	6097.5	445	15X120
568	S606	6082.5	300	15X120
569	S608	6067.5	445	15X120
570	S610	6052.5	300	15X120
571	S612	6037.5	445	15X120
572	S614	6022.5	300	15X120
573	S616	6007.5	445	15X120
574	S618	5992.5	300	15X120
575	S620	5977.5	445	15X120
576	S622	5962.5	300	15X120
577	S624	5947.5	445	15X120
578	S626	5932.5	300	15X120
579	S628	5917.5	445	15X120
580	S630	5902.5	300	15X120
581	S632	5887.5	445	15X120
582	S634	5872.5	300	15X120
583	S636	5857.5	445	15X120
584	S638	5842.5	300	15X120
585	S640	5827.5	445	15X120
586	S642	5812.5	300	15X120
587	S644	5797.5	445	15X120
588	S646	5782.5	300	15X120
589	S648	5767.5	445	15X120
590	S650	5752.5	300	15X120
591	S652	5737.5	445	15X120
592	S654	5722.5	300	15X120
593	S656	5707.5	445	15X120
594	S658	5692.5	300	15X120
595	S660	5677.5	445	15X120
596	S662	5662.5	300	15X120
597	S664	5647.5	445	15X120
598	S666	5632.5	300	15X120
599	S668	5617.5	445	15X120
600	S670	5602.5	300	15X120

No.	Name	X	Y	Bump size(μm)
601	S672	5587.5	445	15X120
602	S674	5572.5	300	15X120
603	S676	5557.5	445	15X120
604	S678	5542.5	300	15X120
605	S680	5527.5	445	15X120
606	S682	5512.5	300	15X120
607	S684	5497.5	445	15X120
608	S686	5482.5	300	15X120
609	S688	5467.5	445	15X120
610	S690	5452.5	300	15X120
611	S692	5437.5	445	15X120
612	S694	5422.5	300	15X120
613	S696	5407.5	445	15X120
614	S698	5392.5	300	15X120
615	S700	5377.5	445	15X120
616	S702	5362.5	300	15X120
617	S704	5347.5	445	15X120
618	S706	5332.5	300	15X120
619	S708	5317.5	445	15X120
620	S710	5302.5	300	15X120
621	S712	5287.5	445	15X120
622	S714	5272.5	300	15X120
623	S716	5257.5	445	15X120
624	S718	5242.5	300	15X120
625	S720	5227.5	445	15X120
626	S722	5212.5	300	15X120
627	S724	5197.5	445	15X120
628	S726	5182.5	300	15X120
629	S728	5167.5	445	15X120
630	S730	5152.5	300	15X120
631	S732	5137.5	445	15X120
632	S734	5122.5	300	15X120
633	S736	5107.5	445	15X120
634	S738	5092.5	300	15X120
635	S740	5077.5	445	15X120
636	S742	5062.5	300	15X120
637	S744	5047.5	445	15X120
638	S746	5032.5	300	15X120
639	S748	5017.5	445	15X120
640	S750	5002.5	300	15X120
641	S752	4987.5	445	15X120
642	S754	4972.5	300	15X120
643	S756	4957.5	445	15X120
644	S758	4942.5	300	15X120
645	S760	4927.5	445	15X120
646	S762	4912.5	300	15X120
647	S764	4897.5	445	15X120
648	S766	4882.5	300	15X120
649	S768	4867.5	445	15X120
650	S770	4852.5	300	15X120
651	S772	4837.5	445	15X120
652	S774	4822.5	300	15X120
653	S776	4807.5	445	15X120
654	S778	4792.5	300	15X120
655	S780	4777.5	445	15X120
656	S782	4762.5	300	15X120
657	S784	4747.5	445	15X120
658	S786	4732.5	300	15X120
659	S788	4717.5	445	15X120
660	S790	4702.5	300	15X120

No.	Name	X	Y	Bump size(μm)
661	S792	4687.5	445	15X120
662	S794	4672.5	300	15X120
663	S796	4657.5	445	15X120
664	S798	4642.5	300	15X120
665	S800	4627.5	445	15X120
666	DUM160	4612.5	300	15X120
667	DUM161	4597.5	445	15X120
668	DUM162	4582.5	300	15X120
669	DUM163	4567.5	445	15X120
670	DUM164	4552.5	300	15X120
671	DUM165	4537.5	445	15X120
672	DUM166	4522.5	300	15X120
673	DUM167	4507.5	445	15X120
674	G600	4492.5	300	15X120
675	G599	4477.5	445	15X120
676	G598	4462.5	300	15X120
677	G597	4447.5	445	15X120
678	G596	4432.5	300	15X120
679	G595	4417.5	445	15X120
680	G594	4402.5	300	15X120
681	G593	4387.5	445	15X120
682	G592	4372.5	300	15X120
683	G591	4357.5	445	15X120
684	G590	4342.5	300	15X120
685	G589	4327.5	445	15X120
686	G588	4312.5	300	15X120
687	G587	4297.5	445	15X120
688	G586	4282.5	300	15X120
689	G585	4267.5	445	15X120
690	G584	4252.5	300	15X120
691	G583	4237.5	445	15X120
692	G582	4222.5	300	15X120
693	G581	4207.5	445	15X120
694	G580	4192.5	300	15X120
695	G579	4177.5	445	15X120
696	G578	4162.5	300	15X120
697	G577	4147.5	445	15X120
698	G576	4132.5	300	15X120
699	G575	4117.5	445	15X120
700	G574	4102.5	300	15X120
701	G573	4087.5	445	15X120
702	G572	4072.5	300	15X120
703	G571	4057.5	445	15X120
704	G570	4042.5	300	15X120
705	G569	4027.5	445	15X120
706	G568	4012.5	300	15X120
707	G567	3997.5	445	15X120
708	G566	3982.5	300	15X120
709	G565	3967.5	445	15X120
710	G564	3952.5	300	15X120
711	G563	3937.5	445	15X120
712	G562	3922.5	300	15X120
713	G561	3907.5	445	15X120
714	G560	3892.5	300	15X120
715	G559	3877.5	445	15X120
716	G558	3862.5	300	15X120
717	G557	3847.5	445	15X120
718	G556	3832.5	300	15X120
719	G555	3817.5	445	15X120
720	G554	3802.5	300	15X120

No.	Name	X	Y	Bump size(μm)
721	G553	3787.5	445	15X120
722	G552	3772.5	300	15X120
723	G551	3757.5	445	15X120
724	G550	3742.5	300	15X120
725	G549	3727.5	445	15X120
726	G548	3712.5	300	15X120
727	G547	3697.5	445	15X120
728	G546	3682.5	300	15X120
729	G545	3667.5	445	15X120
730	G544	3652.5	300	15X120
731	G543	3637.5	445	15X120
732	G542	3622.5	300	15X120
733	G541	3607.5	445	15X120
734	G540	3592.5	300	15X120
735	G539	3577.5	445	15X120
736	G538	3562.5	300	15X120
737	G537	3547.5	445	15X120
738	G536	3532.5	300	15X120
739	G535	3517.5	445	15X120
740	G534	3502.5	300	15X120
741	G533	3487.5	445	15X120
742	G532	3472.5	300	15X120
743	G531	3457.5	445	15X120
744	G530	3442.5	300	15X120
745	G529	3427.5	445	15X120
746	G528	3412.5	300	15X120
747	G527	3397.5	445	15X120
748	G526	3382.5	300	15X120
749	G525	3367.5	445	15X120
750	G524	3352.5	300	15X120
751	G523	3337.5	445	15X120
752	G522	3322.5	300	15X120
753	G521	3307.5	445	15X120
754	G520	3292.5	300	15X120
755	G519	3277.5	445	15X120
756	G518	3262.5	300	15X120
757	G517	3247.5	445	15X120
758	G516	3232.5	300	15X120
759	G515	3217.5	445	15X120
760	G514	3202.5	300	15X120
761	G513	3187.5	445	15X120
762	G512	3172.5	300	15X120
763	G511	3157.5	445	15X120
764	G510	3142.5	300	15X120
765	G509	3127.5	445	15X120
766	G508	3112.5	300	15X120
767	G507	3097.5	445	15X120
768	G506	3082.5	300	15X120
769	G505	3067.5	445	15X120
770	G504	3052.5	300	15X120
771	G503	3037.5	445	15X120
772	G502	3022.5	300	15X120
773	G501	3007.5	445	15X120
774	G500	2992.5	300	15X120
775	G499	2977.5	445	15X120
776	G498	2962.5	300	15X120
777	G497	2947.5	445	15X120
778	G496	2932.5	300	15X120
779	G495	2917.5	445	15X120
780	G494	2902.5	300	15X120

No.	Name	X	Y	Bump size(μm)
781	G493	2887.5	445	15X120
782	G492	2872.5	300	15X120
783	G491	2857.5	445	15X120
784	G490	2842.5	300	15X120
785	G489	2827.5	445	15X120
786	G488	2812.5	300	15X120
787	G487	2797.5	445	15X120
788	G486	2782.5	300	15X120
789	G485	2767.5	445	15X120
790	G484	2752.5	300	15X120
791	G483	2737.5	445	15X120
792	G482	2722.5	300	15X120
793	G481	2707.5	445	15X120
794	G480	2692.5	300	15X120
795	G479	2677.5	445	15X120
796	G478	2662.5	300	15X120
797	G477	2647.5	445	15X120
798	G476	2632.5	300	15X120
799	G475	2617.5	445	15X120
800	G474	2602.5	300	15X120
801	G473	2587.5	445	15X120
802	G472	2572.5	300	15X120
803	G471	2557.5	445	15X120
804	G470	2542.5	300	15X120
805	G469	2527.5	445	15X120
806	G468	2512.5	300	15X120
807	G467	2497.5	445	15X120
808	G466	2482.5	300	15X120
809	G465	2467.5	445	15X120
810	G464	2452.5	300	15X120
811	G463	2437.5	445	15X120
812	G462	2422.5	300	15X120
813	G461	2407.5	445	15X120
814	G460	2392.5	300	15X120
815	G459	2377.5	445	15X120
816	G458	2362.5	300	15X120
817	G457	2347.5	445	15X120
818	G456	2332.5	300	15X120
819	G455	2317.5	445	15X120
820	G454	2302.5	300	15X120
821	G453	2287.5	445	15X120
822	G452	2272.5	300	15X120
823	G451	2257.5	445	15X120
824	G450	2242.5	300	15X120
825	G449	2227.5	445	15X120
826	G448	2212.5	300	15X120
827	G447	2197.5	445	15X120
828	G446	2182.5	300	15X120
829	G445	2167.5	445	15X120
830	G444	2152.5	300	15X120
831	G443	2137.5	445	15X120
832	G442	2122.5	300	15X120
833	G441	2107.5	445	15X120
834	G440	2092.5	300	15X120
835	G439	2077.5	445	15X120
836	G438	2062.5	300	15X120
837	G437	2047.5	445	15X120
838	G436	2032.5	300	15X120
839	G435	2017.5	445	15X120
840	G434	2002.5	300	15X120

No.	Name	X	Y	Bump size(μm)
841	G433	1987.5	445	15X120
842	G432	1972.5	300	15X120
843	G431	1957.5	445	15X120
844	G430	1942.5	300	15X120
845	G429	1927.5	445	15X120
846	G428	1912.5	300	15X120
847	G427	1897.5	445	15X120
848	G426	1882.5	300	15X120
849	G425	1867.5	445	15X120
850	G424	1852.5	300	15X120
851	G423	1837.5	445	15X120
852	G422	1822.5	300	15X120
853	G421	1807.5	445	15X120
854	G420	1792.5	300	15X120
855	G419	1777.5	445	15X120
856	G418	1762.5	300	15X120
857	G417	1747.5	445	15X120
858	G416	1732.5	300	15X120
859	G415	1717.5	445	15X120
860	G414	1702.5	300	15X120
861	G413	1687.5	445	15X120
862	G412	1672.5	300	15X120
863	G411	1657.5	445	15X120
864	G410	1642.5	300	15X120
865	G409	1627.5	445	15X120
866	G408	1612.5	300	15X120
867	G407	1597.5	445	15X120
868	G406	1582.5	300	15X120
869	G405	1567.5	445	15X120
870	G404	1552.5	300	15X120
871	G403	1537.5	445	15X120
872	G402	1522.5	300	15X120
873	G401	1507.5	445	15X120
874	G400	1492.5	300	15X120
875	G399	1477.5	445	15X120
876	G398	1462.5	300	15X120
877	G397	1447.5	445	15X120
878	G396	1432.5	300	15X120
879	G395	1417.5	445	15X120
880	G394	1402.5	300	15X120
881	G393	1387.5	445	15X120
882	G392	1372.5	300	15X120
883	G391	1357.5	445	15X120
884	G390	1342.5	300	15X120
885	G389	1327.5	445	15X120
886	G388	1312.5	300	15X120
887	G387	1297.5	445	15X120
888	G386	1282.5	300	15X120
889	G385	1267.5	445	15X120
890	G384	1252.5	300	15X120
891	G383	1237.5	445	15X120
892	G382	1222.5	300	15X120
893	G381	1207.5	445	15X120
894	G380	1192.5	300	15X120
895	G379	1177.5	445	15X120
896	G378	1162.5	300	15X120
897	G377	1147.5	445	15X120
898	G376	1132.5	300	15X120
899	G375	1117.5	445	15X120
900	G374	1102.5	300	15X120

No.	Name	X	Y	Bump size(μm)
901	G373	1087.5	445	15X120
902	G372	1072.5	300	15X120
903	G371	1057.5	445	15X120
904	G370	1042.5	300	15X120
905	G369	1027.5	445	15X120
906	G368	1012.5	300	15X120
907	G367	997.5	445	15X120
908	G366	982.5	300	15X120
909	G365	967.5	445	15X120
910	G364	952.5	300	15X120
911	G363	937.5	445	15X120
912	G362	922.5	300	15X120
913	G361	907.5	445	15X120
914	G360	892.5	300	15X120
915	G359	877.5	445	15X120
916	G358	862.5	300	15X120
917	G357	847.5	445	15X120
918	G356	832.5	300	15X120
919	G355	817.5	445	15X120
920	G354	802.5	300	15X120
921	G353	787.5	445	15X120
922	G352	772.5	300	15X120
923	G351	757.5	445	15X120
924	G350	742.5	300	15X120
925	G349	727.5	445	15X120
926	G348	712.5	300	15X120
927	G347	697.5	445	15X120
928	G346	682.5	300	15X120
929	G345	667.5	445	15X120
930	G344	652.5	300	15X120
931	G343	637.5	445	15X120
932	G342	622.5	300	15X120
933	G341	607.5	445	15X120
934	G340	592.5	300	15X120
935	G339	577.5	445	15X120
936	G338	562.5	300	15X120
937	G337	547.5	445	15X120
938	G336	532.5	300	15X120
939	G335	517.5	445	15X120
940	G334	502.5	300	15X120
941	G333	487.5	445	15X120
942	G332	472.5	300	15X120
943	G331	457.5	445	15X120
944	G330	442.5	300	15X120
945	G329	427.5	445	15X120
946	G328	412.5	300	15X120
947	G327	397.5	445	15X120
948	G326	382.5	300	15X120
949	G325	367.5	445	15X120
950	G324	352.5	300	15X120
951	G323	337.5	445	15X120
952	G322	322.5	300	15X120
953	G321	307.5	445	15X120
954	G320	292.5	300	15X120
955	G319	277.5	445	15X120
956	G318	262.5	300	15X120
957	G317	247.5	445	15X120
958	G316	232.5	300	15X120
959	G315	217.5	445	15X120
960	G314	202.5	300	15X120

No.	Name	X	Y	Bump size(μm)
961	G313	187.5	445	15X120
962	G312	172.5	300	15X120
963	G311	157.5	445	15X120
964	G310	142.5	300	15X120
965	G309	127.5	445	15X120
966	G308	112.5	300	15X120
967	G307	97.5	445	15X120
968	G306	82.5	300	15X120
969	G305	67.5	445	15X120
970	G304	52.5	300	15X120
971	G303	37.5	445	15X120
972	G302	22.5	300	15X120
973	G301	7.5	445	15X120
974	G300	-7.5	300	15X120
975	G299	-22.5	445	15X120
976	G298	-37.5	300	15X120
977	G297	-52.5	445	15X120
978	G296	-67.5	300	15X120
979	G295	-82.5	445	15X120
980	G294	-97.5	300	15X120
981	G293	-112.5	445	15X120
982	G292	-127.5	300	15X120
983	G291	-142.5	445	15X120
984	G290	-157.5	300	15X120
985	G289	-172.5	445	15X120
986	G288	-187.5	300	15X120
987	G287	-202.5	445	15X120
988	G286	-217.5	300	15X120
989	G285	-232.5	445	15X120
990	G284	-247.5	300	15X120
991	G283	-262.5	445	15X120
992	G282	-277.5	300	15X120
993	G281	-292.5	445	15X120
994	G280	-307.5	300	15X120
995	G279	-322.5	445	15X120
996	G278	-337.5	300	15X120
997	G277	-352.5	445	15X120
998	G276	-367.5	300	15X120
999	G275	-382.5	445	15X120
1000	G274	-397.5	300	15X120
1001	G273	-412.5	445	15X120
1002	G272	-427.5	300	15X120
1003	G271	-442.5	445	15X120
1004	G270	-457.5	300	15X120
1005	G269	-472.5	445	15X120
1006	G268	-487.5	300	15X120
1007	G267	-502.5	445	15X120
1008	G266	-517.5	300	15X120
1009	G265	-532.5	445	15X120
1010	G264	-547.5	300	15X120
1011	G263	-562.5	445	15X120
1012	G262	-577.5	300	15X120
1013	G261	-592.5	445	15X120
1014	G260	-607.5	300	15X120
1015	G259	-622.5	445	15X120
1016	G258	-637.5	300	15X120
1017	G257	-652.5	445	15X120
1018	G256	-667.5	300	15X120
1019	G255	-682.5	445	15X120
1020	G254	-697.5	300	15X120

No.	Name	X	Y	Bump size(μm)
1021	G253	-712.5	445	15X120
1022	G252	-727.5	300	15X120
1023	G251	-742.5	445	15X120
1024	G250	-757.5	300	15X120
1025	G249	-772.5	445	15X120
1026	G248	-787.5	300	15X120
1027	G247	-802.5	445	15X120
1028	G246	-817.5	300	15X120
1029	G245	-832.5	445	15X120
1030	G244	-847.5	300	15X120
1031	G243	-862.5	445	15X120
1032	G242	-877.5	300	15X120
1033	G241	-892.5	445	15X120
1034	G240	-907.5	300	15X120
1035	G239	-922.5	445	15X120
1036	G238	-937.5	300	15X120
1037	G237	-952.5	445	15X120
1038	G236	-967.5	300	15X120
1039	G235	-982.5	445	15X120
1040	G234	-997.5	300	15X120
1041	G233	-1012.5	445	15X120
1042	G232	-1027.5	300	15X120
1043	G231	-1042.5	445	15X120
1044	G230	-1057.5	300	15X120
1045	G229	-1072.5	445	15X120
1046	G228	-1087.5	300	15X120
1047	G227	-1102.5	445	15X120
1048	G226	-1117.5	300	15X120
1049	G225	-1132.5	445	15X120
1050	G224	-1147.5	300	15X120
1051	G223	-1162.5	445	15X120
1052	G222	-1177.5	300	15X120
1053	G221	-1192.5	445	15X120
1054	G220	-1207.5	300	15X120
1055	G219	-1222.5	445	15X120
1056	G218	-1237.5	300	15X120
1057	G217	-1252.5	445	15X120
1058	G216	-1267.5	300	15X120
1059	G215	-1282.5	445	15X120
1060	G214	-1297.5	300	15X120
1061	G213	-1312.5	445	15X120
1062	G212	-1327.5	300	15X120
1063	G211	-1342.5	445	15X120
1064	G210	-1357.5	300	15X120
1065	G209	-1372.5	445	15X120
1066	G208	-1387.5	300	15X120
1067	G207	-1402.5	445	15X120
1068	G206	-1417.5	300	15X120
1069	G205	-1432.5	445	15X120
1070	G204	-1447.5	300	15X120
1071	G203	-1462.5	445	15X120
1072	G202	-1477.5	300	15X120
1073	G201	-1492.5	445	15X120
1074	G200	-1507.5	300	15X120
1075	G199	-1522.5	445	15X120
1076	G198	-1537.5	300	15X120
1077	G197	-1552.5	445	15X120
1078	G196	-1567.5	300	15X120
1079	G195	-1582.5	445	15X120
1080	G194	-1597.5	300	15X120

No.	Name	X	Y	Bump size(μm)
1081	G193	-1612.5	445	15X120
1082	G192	-1627.5	300	15X120
1083	G191	-1642.5	445	15X120
1084	G190	-1657.5	300	15X120
1085	G189	-1672.5	445	15X120
1086	G188	-1687.5	300	15X120
1087	G187	-1702.5	445	15X120
1088	G186	-1717.5	300	15X120
1089	G185	-1732.5	445	15X120
1090	G184	-1747.5	300	15X120
1091	G183	-1762.5	445	15X120
1092	G182	-1777.5	300	15X120
1093	G181	-1792.5	445	15X120
1094	G180	-1807.5	300	15X120
1095	G179	-1822.5	445	15X120
1096	G178	-1837.5	300	15X120
1097	G177	-1852.5	445	15X120
1098	G176	-1867.5	300	15X120
1099	G175	-1882.5	445	15X120
1100	G174	-1897.5	300	15X120
1101	G173	-1912.5	445	15X120
1102	G172	-1927.5	300	15X120
1103	G171	-1942.5	445	15X120
1104	G170	-1957.5	300	15X120
1105	G169	-1972.5	445	15X120
1106	G168	-1987.5	300	15X120
1107	G167	-2002.5	445	15X120
1108	G166	-2017.5	300	15X120
1109	G165	-2032.5	445	15X120
1110	G164	-2047.5	300	15X120
1111	G163	-2062.5	445	15X120
1112	G162	-2077.5	300	15X120
1113	G161	-2092.5	445	15X120
1114	G160	-2107.5	300	15X120
1115	G159	-2122.5	445	15X120
1116	G158	-2137.5	300	15X120
1117	G157	-2152.5	445	15X120
1118	G156	-2167.5	300	15X120
1119	G155	-2182.5	445	15X120
1120	G154	-2197.5	300	15X120
1121	G153	-2212.5	445	15X120
1122	G152	-2227.5	300	15X120
1123	G151	-2242.5	445	15X120
1124	G150	-2257.5	300	15X120
1125	G149	-2272.5	445	15X120
1126	G148	-2287.5	300	15X120
1127	G147	-2302.5	445	15X120
1128	G146	-2317.5	300	15X120
1129	G145	-2332.5	445	15X120
1130	G144	-2347.5	300	15X120
1131	G143	-2362.5	445	15X120
1132	G142	-2377.5	300	15X120
1133	G141	-2392.5	445	15X120
1134	G140	-2407.5	300	15X120
1135	G139	-2422.5	445	15X120
1136	G138	-2437.5	300	15X120
1137	G137	-2452.5	445	15X120
1138	G136	-2467.5	300	15X120
1139	G135	-2482.5	445	15X120
1140	G134	-2497.5	300	15X120

No.	Name	X	Y	Bump size(μm)
1141	G133	-2512.5	445	15X120
1142	G132	-2527.5	300	15X120
1143	G131	-2542.5	445	15X120
1144	G130	-2557.5	300	15X120
1145	G129	-2572.5	445	15X120
1146	G128	-2587.5	300	15X120
1147	G127	-2602.5	445	15X120
1148	G126	-2617.5	300	15X120
1149	G125	-2632.5	445	15X120
1150	G124	-2647.5	300	15X120
1151	G123	-2662.5	445	15X120
1152	G122	-2677.5	300	15X120
1153	G121	-2692.5	445	15X120
1154	G120	-2707.5	300	15X120
1155	G119	-2722.5	445	15X120
1156	G118	-2737.5	300	15X120
1157	G117	-2752.5	445	15X120
1158	G116	-2767.5	300	15X120
1159	G115	-2782.5	445	15X120
1160	G114	-2797.5	300	15X120
1161	G113	-2812.5	445	15X120
1162	G112	-2827.5	300	15X120
1163	G111	-2842.5	445	15X120
1164	G110	-2857.5	300	15X120
1165	G109	-2872.5	445	15X120
1166	G108	-2887.5	300	15X120
1167	G107	-2902.5	445	15X120
1168	G106	-2917.5	300	15X120
1169	G105	-2932.5	445	15X120
1170	G104	-2947.5	300	15X120
1171	G103	-2962.5	445	15X120
1172	G102	-2977.5	300	15X120
1173	G101	-2992.5	445	15X120
1174	G100	-3007.5	300	15X120
1175	G99	-3022.5	445	15X120
1176	G98	-3037.5	300	15X120
1177	G97	-3052.5	445	15X120
1178	G96	-3067.5	300	15X120
1179	G95	-3082.5	445	15X120
1180	G94	-3097.5	300	15X120
1181	G93	-3112.5	445	15X120
1182	G92	-3127.5	300	15X120
1183	G91	-3142.5	445	15X120
1184	G90	-3157.5	300	15X120
1185	G89	-3172.5	445	15X120
1186	G88	-3187.5	300	15X120
1187	G87	-3202.5	445	15X120
1188	G86	-3217.5	300	15X120
1189	G85	-3232.5	445	15X120
1190	G84	-3247.5	300	15X120
1191	G83	-3262.5	445	15X120
1192	G82	-3277.5	300	15X120
1193	G81	-3292.5	445	15X120
1194	G80	-3307.5	300	15X120
1195	G79	-3322.5	445	15X120
1196	G78	-3337.5	300	15X120
1197	G77	-3352.5	445	15X120
1198	G76	-3367.5	300	15X120
1199	G75	-3382.5	445	15X120
1200	G74	-3397.5	300	15X120

No.	Name	X	Y	Bump size(μm)
1201	G73	-3412.5	445	15X120
1202	G72	-3427.5	300	15X120
1203	G71	-3442.5	445	15X120
1204	G70	-3457.5	300	15X120
1205	G69	-3472.5	445	15X120
1206	G68	-3487.5	300	15X120
1207	G67	-3502.5	445	15X120
1208	G66	-3517.5	300	15X120
1209	G65	-3532.5	445	15X120
1210	G64	-3547.5	300	15X120
1211	G63	-3562.5	445	15X120
1212	G62	-3577.5	300	15X120
1213	G61	-3592.5	445	15X120
1214	G60	-3607.5	300	15X120
1215	G59	-3622.5	445	15X120
1216	G58	-3637.5	300	15X120
1217	G57	-3652.5	445	15X120
1218	G56	-3667.5	300	15X120
1219	G55	-3682.5	445	15X120
1220	G54	-3697.5	300	15X120
1221	G53	-3712.5	445	15X120
1222	G52	-3727.5	300	15X120
1223	G51	-3742.5	445	15X120
1224	G50	-3757.5	300	15X120
1225	G49	-3772.5	445	15X120
1226	G48	-3787.5	300	15X120
1227	G47	-3802.5	445	15X120
1228	G46	-3817.5	300	15X120
1229	G45	-3832.5	445	15X120
1230	G44	-3847.5	300	15X120
1231	G43	-3862.5	445	15X120
1232	G42	-3877.5	300	15X120
1233	G41	-3892.5	445	15X120
1234	G40	-3907.5	300	15X120
1235	G39	-3922.5	445	15X120
1236	G38	-3937.5	300	15X120
1237	G37	-3952.5	445	15X120
1238	G36	-3967.5	300	15X120
1239	G35	-3982.5	445	15X120
1240	G34	-3997.5	300	15X120
1241	G33	-4012.5	445	15X120
1242	G32	-4027.5	300	15X120
1243	G31	-4042.5	445	15X120
1244	G30	-4057.5	300	15X120
1245	G29	-4072.5	445	15X120
1246	G28	-4087.5	300	15X120
1247	G27	-4102.5	445	15X120
1248	G26	-4117.5	300	15X120
1249	G25	-4132.5	445	15X120
1250	G24	-4147.5	300	15X120
1251	G23	-4162.5	445	15X120
1252	G22	-4177.5	300	15X120
1253	G21	-4192.5	445	15X120
1254	G20	-4207.5	300	15X120
1255	G19	-4222.5	445	15X120
1256	G18	-4237.5	300	15X120
1257	G17	-4252.5	445	15X120
1258	G16	-4267.5	300	15X120
1259	G15	-4282.5	445	15X120
1260	G14	-4297.5	300	15X120

No.	Name	X	Y	Bump size(μm)
1261	G13	-4312.5	445	15X120
1262	G12	-4327.5	300	15X120
1263	G11	-4342.5	445	15X120
1264	G10	-4357.5	300	15X120
1265	G9	-4372.5	445	15X120
1266	G8	-4387.5	300	15X120
1267	G7	-4402.5	445	15X120
1268	G6	-4417.5	300	15X120
1269	G5	-4432.5	445	15X120
1270	G4	-4447.5	300	15X120
1271	G3	-4462.5	445	15X120
1272	G2	-4477.5	300	15X120
1273	G1	-4492.5	445	15X120
1274	DUM168	-4507.5	300	15X120
1275	DUM169	-4522.5	445	15X120
1276	DUM170	-4537.5	300	15X120
1277	DUM171	-4552.5	445	15X120
1278	DUM172	-4567.5	300	15X120
1279	DUM173	-4582.5	445	15X120
1280	DUM174	-4597.5	300	15X120
1281	DUM175	-4612.5	445	15X120
1282	S799	-4627.5	300	15X120
1283	S797	-4642.5	445	15X120
1284	S795	-4657.5	300	15X120
1285	S793	-4672.5	445	15X120
1286	S791	-4687.5	300	15X120
1287	S789	-4702.5	445	15X120
1288	S787	-4717.5	300	15X120
1289	S785	-4732.5	445	15X120
1290	S783	-4747.5	300	15X120
1291	S781	-4762.5	445	15X120
1292	S779	-4777.5	300	15X120
1293	S777	-4792.5	445	15X120
1294	S775	-4807.5	300	15X120
1295	S773	-4822.5	445	15X120
1296	S771	-4837.5	300	15X120
1297	S769	-4852.5	445	15X120
1298	S767	-4867.5	300	15X120
1299	S765	-4882.5	445	15X120
1300	S763	-4897.5	300	15X120
1301	S761	-4912.5	445	15X120
1302	S759	-4927.5	300	15X120
1303	S757	-4942.5	445	15X120
1304	S755	-4957.5	300	15X120
1305	S753	-4972.5	445	15X120
1306	S751	-4987.5	300	15X120
1307	S749	-5002.5	445	15X120
1308	S747	-5017.5	300	15X120
1309	S745	-5032.5	445	15X120
1310	S743	-5047.5	300	15X120
1311	S741	-5062.5	445	15X120
1312	S739	-5077.5	300	15X120
1313	S737	-5092.5	445	15X120
1314	S735	-5107.5	300	15X120
1315	S733	-5122.5	445	15X120
1316	S731	-5137.5	300	15X120
1317	S729	-5152.5	445	15X120
1318	S727	-5167.5	300	15X120
1319	S725	-5182.5	445	15X120
1320	S723	-5197.5	300	15X120

No.	Name	X	Y	Bump size(μm)
1321	S721	-5212.5	445	15X120
1322	S719	-5227.5	300	15X120
1323	S717	-5242.5	445	15X120
1324	S715	-5257.5	300	15X120
1325	S713	-5272.5	445	15X120
1326	S711	-5287.5	300	15X120
1327	S709	-5302.5	445	15X120
1328	S707	-5317.5	300	15X120
1329	S705	-5332.5	445	15X120
1330	S703	-5347.5	300	15X120
1331	S701	-5362.5	445	15X120
1332	S699	-5377.5	300	15X120
1333	S697	-5392.5	445	15X120
1334	S695	-5407.5	300	15X120
1335	S693	-5422.5	445	15X120
1336	S691	-5437.5	300	15X120
1337	S689	-5452.5	445	15X120
1338	S687	-5467.5	300	15X120
1339	S685	-5482.5	445	15X120
1340	S683	-5497.5	300	15X120
1341	S681	-5512.5	445	15X120
1342	S679	-5527.5	300	15X120
1343	S677	-5542.5	445	15X120
1344	S675	-5557.5	300	15X120
1345	S673	-5572.5	445	15X120
1346	S671	-5587.5	300	15X120
1347	S669	-5602.5	445	15X120
1348	S667	-5617.5	300	15X120
1349	S665	-5632.5	445	15X120
1350	S663	-5647.5	300	15X120
1351	S661	-5662.5	445	15X120
1352	S659	-5677.5	300	15X120
1353	S657	-5692.5	445	15X120
1354	S655	-5707.5	300	15X120
1355	S653	-5722.5	445	15X120
1356	S651	-5737.5	300	15X120
1357	S649	-5752.5	445	15X120
1358	S647	-5767.5	300	15X120
1359	S645	-5782.5	445	15X120
1360	S643	-5797.5	300	15X120
1361	S641	-5812.5	445	15X120
1362	S639	-5827.5	300	15X120
1363	S637	-5842.5	445	15X120
1364	S635	-5857.5	300	15X120
1365	S633	-5872.5	445	15X120
1366	S631	-5887.5	300	15X120
1367	S629	-5902.5	445	15X120
1368	S627	-5917.5	300	15X120
1369	S625	-5932.5	445	15X120
1370	S623	-5947.5	300	15X120
1371	S621	-5962.5	445	15X120
1372	S619	-5977.5	300	15X120
1373	S617	-5992.5	445	15X120
1374	S615	-6007.5	300	15X120
1375	S613	-6022.5	445	15X120
1376	S611	-6037.5	300	15X120
1377	S609	-6052.5	445	15X120
1378	S607	-6067.5	300	15X120
1379	S605	-6082.5	445	15X120
1380	S603	-6097.5	300	15X120

No.	Name	X	Y	Bump size(μm)
1381	S601	-6112.5	445	15X120
1382	S599	-6127.5	300	15X120
1383	S597	-6142.5	445	15X120
1384	S595	-6157.5	300	15X120
1385	S593	-6172.5	445	15X120
1386	S591	-6187.5	300	15X120
1387	S589	-6202.5	445	15X120
1388	S587	-6217.5	300	15X120
1389	S585	-6232.5	445	15X120
1390	S583	-6247.5	300	15X120
1391	S581	-6262.5	445	15X120
1392	S579	-6277.5	300	15X120
1393	S577	-6292.5	445	15X120
1394	S575	-6307.5	300	15X120
1395	S573	-6322.5	445	15X120
1396	S571	-6337.5	300	15X120
1397	S569	-6352.5	445	15X120
1398	S567	-6367.5	300	15X120
1399	S565	-6382.5	445	15X120
1400	S563	-6397.5	300	15X120
1401	S561	-6412.5	445	15X120
1402	S559	-6427.5	300	15X120
1403	S557	-6442.5	445	15X120
1404	S555	-6457.5	300	15X120
1405	S553	-6472.5	445	15X120
1406	S551	-6487.5	300	15X120
1407	S549	-6502.5	445	15X120
1408	S547	-6517.5	300	15X120
1409	S545	-6532.5	445	15X120
1410	S543	-6547.5	300	15X120
1411	S541	-6562.5	445	15X120
1412	S539	-6577.5	300	15X120
1413	S537	-6592.5	445	15X120
1414	S535	-6607.5	300	15X120
1415	S533	-6622.5	445	15X120
1416	S531	-6637.5	300	15X120
1417	S529	-6652.5	445	15X120
1418	S527	-6667.5	300	15X120
1419	S525	-6682.5	445	15X120
1420	S523	-6697.5	300	15X120
1421	S521	-6712.5	445	15X120
1422	S519	-6727.5	300	15X120
1423	S517	-6742.5	445	15X120
1424	S515	-6757.5	300	15X120
1425	S513	-6772.5	445	15X120
1426	S511	-6787.5	300	15X120
1427	S509	-6802.5	445	15X120
1428	S507	-6817.5	300	15X120
1429	S505	-6832.5	445	15X120
1430	S503	-6847.5	300	15X120
1431	S501	-6862.5	445	15X120
1432	S499	-6877.5	300	15X120
1433	S497	-6892.5	445	15X120
1434	S495	-6907.5	300	15X120
1435	S493	-6922.5	445	15X120
1436	S491	-6937.5	300	15X120
1437	S489	-6952.5	445	15X120
1438	S487	-6967.5	300	15X120
1439	S485	-6982.5	445	15X120
1440	S483	-6997.5	300	15X120

No.	Name	X	Y	Bump size(μm)
1441	S481	-7012.5	445	15X120
1442	S479	-7027.5	300	15X120
1443	S477	-7042.5	445	15X120
1444	S475	-7057.5	300	15X120
1445	S473	-7072.5	445	15X120
1446	S471	-7087.5	300	15X120
1447	S469	-7102.5	445	15X120
1448	S467	-7117.5	300	15X120
1449	S465	-7132.5	445	15X120
1450	S463	-7147.5	300	15X120
1451	S461	-7162.5	445	15X120
1452	S459	-7177.5	300	15X120
1453	S457	-7192.5	445	15X120
1454	S455	-7207.5	300	15X120
1455	S453	-7222.5	445	15X120
1456	S451	-7237.5	300	15X120
1457	S449	-7252.5	445	15X120
1458	S447	-7267.5	300	15X120
1459	S445	-7282.5	445	15X120
1460	S443	-7297.5	300	15X120
1461	S441	-7312.5	445	15X120
1462	S439	-7327.5	300	15X120
1463	S437	-7342.5	445	15X120
1464	S435	-7357.5	300	15X120
1465	S433	-7372.5	445	15X120
1466	S431	-7387.5	300	15X120
1467	S429	-7402.5	445	15X120
1468	S427	-7417.5	300	15X120
1469	S425	-7432.5	445	15X120
1470	S423	-7447.5	300	15X120
1471	S421	-7462.5	445	15X120
1472	S419	-7477.5	300	15X120
1473	S417	-7492.5	445	15X120
1474	S415	-7507.5	300	15X120
1475	S413	-7522.5	445	15X120
1476	S411	-7537.5	300	15X120
1477	S409	-7552.5	445	15X120
1478	S407	-7567.5	300	15X120
1479	S405	-7582.5	445	15X120
1480	S403	-7597.5	300	15X120
1481	S401	-7612.5	445	15X120
1482	S399	-7627.5	300	15X120
1483	S397	-7642.5	445	15X120
1484	S395	-7657.5	300	15X120
1485	S393	-7672.5	445	15X120
1486	S391	-7687.5	300	15X120
1487	S389	-7702.5	445	15X120
1488	S387	-7717.5	300	15X120
1489	S385	-7732.5	445	15X120
1490	S383	-7747.5	300	15X120
1491	S381	-7762.5	445	15X120
1492	S379	-7777.5	300	15X120
1493	S377	-7792.5	445	15X120
1494	S375	-7807.5	300	15X120
1495	S373	-7822.5	445	15X120
1496	S371	-7837.5	300	15X120
1497	S369	-7852.5	445	15X120
1498	S367	-7867.5	300	15X120
1499	S365	-7882.5	445	15X120
1500	S363	-7897.5	300	15X120

No.	Name	X	Y	Bump size(μm)
1501	S361	-7912.5	445	15X120
1502	S359	-7927.5	300	15X120
1503	S357	-7942.5	445	15X120
1504	S355	-7957.5	300	15X120
1505	S353	-7972.5	445	15X120
1506	S351	-7987.5	300	15X120
1507	S349	-8002.5	445	15X120
1508	S347	-8017.5	300	15X120
1509	S345	-8032.5	445	15X120
1510	S343	-8047.5	300	15X120
1511	S341	-8062.5	445	15X120
1512	S339	-8077.5	300	15X120
1513	S337	-8092.5	445	15X120
1514	S335	-8107.5	300	15X120
1515	S333	-8122.5	445	15X120
1516	S331	-8137.5	300	15X120
1517	S329	-8152.5	445	15X120
1518	S327	-8167.5	300	15X120
1519	S325	-8182.5	445	15X120
1520	S323	-8197.5	300	15X120
1521	S321	-8212.5	445	15X120
1522	S319	-8227.5	300	15X120
1523	S317	-8242.5	445	15X120
1524	S315	-8257.5	300	15X120
1525	S313	-8272.5	445	15X120
1526	S311	-8287.5	300	15X120
1527	S309	-8302.5	445	15X120
1528	S307	-8317.5	300	15X120
1529	S305	-8332.5	445	15X120
1530	S303	-8347.5	300	15X120
1531	S301	-8362.5	445	15X120
1532	S299	-8377.5	300	15X120
1533	S297	-8392.5	445	15X120
1534	S295	-8407.5	300	15X120
1535	S293	-8422.5	445	15X120
1536	S291	-8437.5	300	15X120
1537	S289	-8452.5	445	15X120
1538	S287	-8467.5	300	15X120
1539	S285	-8482.5	445	15X120
1540	S283	-8497.5	300	15X120
1541	S281	-8512.5	445	15X120
1542	S279	-8527.5	300	15X120
1543	S277	-8542.5	445	15X120
1544	S275	-8557.5	300	15X120
1545	S273	-8572.5	445	15X120
1546	S271	-8587.5	300	15X120
1547	S269	-8602.5	445	15X120
1548	S267	-8617.5	300	15X120
1549	S265	-8632.5	445	15X120
1550	S263	-8647.5	300	15X120
1551	S261	-8662.5	445	15X120
1552	S259	-8677.5	300	15X120
1553	S257	-8692.5	445	15X120
1554	S255	-8707.5	300	15X120
1555	S253	-8722.5	445	15X120
1556	S251	-8737.5	300	15X120
1557	S249	-8752.5	445	15X120
1558	S247	-8767.5	300	15X120
1559	S245	-8782.5	445	15X120
1560	S243	-8797.5	300	15X120

No.	Name	X	Y	Bump size(μm)
1561	S241	-8812.5	445	15X120
1562	S239	-8827.5	300	15X120
1563	S237	-8842.5	445	15X120
1564	S235	-8857.5	300	15X120
1565	S233	-8872.5	445	15X120
1566	S231	-8887.5	300	15X120
1567	S229	-8902.5	445	15X120
1568	S227	-8917.5	300	15X120
1569	S225	-8932.5	445	15X120
1570	S223	-8947.5	300	15X120
1571	S221	-8962.5	445	15X120
1572	S219	-8977.5	300	15X120
1573	S217	-8992.5	445	15X120
1574	S215	-9007.5	300	15X120
1575	S213	-9022.5	445	15X120
1576	S211	-9037.5	300	15X120
1577	S209	-9052.5	445	15X120
1578	S207	-9067.5	300	15X120
1579	S205	-9082.5	445	15X120
1580	S203	-9097.5	300	15X120
1581	S201	-9112.5	445	15X120
1582	S199	-9127.5	300	15X120
1583	S197	-9142.5	445	15X120
1584	S195	-9157.5	300	15X120
1585	S193	-9172.5	445	15X120
1586	S191	-9187.5	300	15X120
1587	S189	-9202.5	445	15X120
1588	S187	-9217.5	300	15X120
1589	S185	-9232.5	445	15X120
1590	S183	-9247.5	300	15X120
1591	S181	-9262.5	445	15X120
1592	S179	-9277.5	300	15X120
1593	S177	-9292.5	445	15X120
1594	S175	-9307.5	300	15X120
1595	S173	-9322.5	445	15X120
1596	S171	-9337.5	300	15X120
1597	S169	-9352.5	445	15X120
1598	S167	-9367.5	300	15X120
1599	S165	-9382.5	445	15X120
1600	S163	-9397.5	300	15X120
1601	S161	-9412.5	445	15X120
1602	S159	-9427.5	300	15X120
1603	S157	-9442.5	445	15X120
1604	S155	-9457.5	300	15X120
1605	S153	-9472.5	445	15X120
1606	S151	-9487.5	300	15X120
1607	S149	-9502.5	445	15X120
1608	S147	-9517.5	300	15X120
1609	S145	-9532.5	445	15X120
1610	S143	-9547.5	300	15X120
1611	S141	-9562.5	445	15X120
1612	S139	-9577.5	300	15X120
1613	S137	-9592.5	445	15X120
1614	S135	-9607.5	300	15X120
1615	S133	-9622.5	445	15X120
1616	S131	-9637.5	300	15X120
1617	S129	-9652.5	445	15X120
1618	S127	-9667.5	300	15X120
1619	S125	-9682.5	445	15X120
1620	S123	-9697.5	300	15X120
1621	S121	-9712.5	445	15X120
1622	S119	-9727.5	300	15X120

No.	Name	X	Y	Bump size(μm)
1623	S117	-9742.5	445	15X120
1624	S115	-9757.5	300	15X120
1625	S113	-9772.5	445	15X120
1626	S111	-9787.5	300	15X120
1627	S109	-9802.5	445	15X120
1628	S107	-9817.5	300	15X120
1629	S105	-9832.5	445	15X120
1630	S103	-9847.5	300	15X120
1631	S101	-9862.5	445	15X120
1632	S99	-9877.5	300	15X120
1633	S97	-9892.5	445	15X120
1634	S95	-9907.5	300	15X120
1635	S93	-9922.5	445	15X120
1636	S91	-9937.5	300	15X120
1637	S89	-9952.5	445	15X120
1638	S87	-9967.5	300	15X120
1639	S85	-9982.5	445	15X120
1640	S83	-9997.5	300	15X120
1641	S81	-10012.5	445	15X120
1642	S79	-10027.5	300	15X120
1643	S77	-10042.5	445	15X120
1644	S75	-10057.5	300	15X120
1645	S73	-10072.5	445	15X120
1646	S71	-10087.5	300	15X120
1647	S69	-10102.5	445	15X120
1648	S67	-10117.5	300	15X120
1649	S65	-10132.5	445	15X120
1650	S63	-10147.5	300	15X120
1651	S61	-10162.5	445	15X120
1652	S59	-10177.5	300	15X120
1653	S57	-10192.5	445	15X120
1654	S55	-10207.5	300	15X120
1655	S53	-10222.5	445	15X120
1656	S51	-10237.5	300	15X120
1657	S49	-10252.5	445	15X120
1658	S47	-10267.5	300	15X120
1659	S45	-10282.5	445	15X120
1660	S43	-10297.5	300	15X120
1661	S41	-10312.5	445	15X120
1662	S39	-10327.5	300	15X120
1663	S37	-10342.5	445	15X120
1664	S35	-10357.5	300	15X120
1665	S33	-10372.5	445	15X120
1666	S31	-10387.5	300	15X120
1667	S29	-10402.5	445	15X120
1668	S27	-10417.5	300	15X120
1669	S25	-10432.5	445	15X120
1670	S23	-10447.5	300	15X120
1671	S21	-10462.5	445	15X120
1672	S19	-10477.5	300	15X120
1673	S17	-10492.5	445	15X120
1674	S15	-10507.5	300	15X120
1675	S13	-10522.5	445	15X120
1676	S11	-10537.5	300	15X120
1677	S9	-10552.5	445	15X120
1678	S7	-10567.5	300	15X120
1679	S5	-10582.5	445	15X120
1680	S3	-10597.5	300	15X120
1681	S1	-10612.5	445	15X120
1682	DUM176	-10627.5	300	15X120
1683	DUM177	-10642.5	445	15X120

9.4 Alignment mark center coordinates

Name	X	Y
L_AMK	-10750	447
R_AMK	10750	447

Himax Confidential
Do Not Copy

10. Ordering Information

Part No.	Package
HX8705-B000PDxxx	PD: mean COG xxx: mean chip thickness (μm) , (default 400 μm)

11. Revision History

Version	Date	Description of Changes
01	2010/04/27	New setup
	2010/05/25	Page16 & 31 Modify alignment mark center coordinates.
	2010/06/21	Page14 Modify LE off delay time (t_{PD2}). Page16 Add dummy pads.

Himax Confidential
Do Not Copy