

	Confidential	

Application Note for CTPM

Application Note for CTPM	
Project name	Touch panel
Document ref	[Document ref]
Version	0.4
Release date	18 Jan 2010
Owner	Xiaoxu Du
Classification	Confidential
Distribution List	[Distribution list]
Approval	

This document contains information proprietary to FocalTech Systems, Ltd., and may not be reproduced, disclosed or used in whole or part without the express written permission of FocalTech Systems, Ltd.

Copyright © 2012, FocalTech Systems, Ltd
All rights reserved

R3-B4-A, South Area, Shenzhen Hi-Tech Industrial Park,
Shenzhen, Gungdong, P.R. China
ZIP :518057
T +86 755 26588222
F +86 755 26712499
E support@focaltech-systems.com

www.focaltech-systems.com

CTPM Application Note

Revision History

Date	Version	List of changes	Author + Signature
18 Jan, 2010	0.1	Initial draft	Xiaoxu Du
17 Mar, 2010	0.2	Add raw data protocol	Xiaoxu Du
22 Mar, 2010	0.3	Add system information protocol	Xiaoxu Du
26 Mar, 2010	0.4	Add calibration related parameters	Xiaoxu Du
08 May, 2010	0.5	Add information to operating mode	Xinming Wang
07 Jul, 2010	0.6	Change Protocol and add information	Yunfeng Yuan
02 Sep, 2010	0.7	Add Test Mode 1 for big size module	Yunfeng Yuan
02 Dec, 2010	0.7	Modified Default value of Registers Consistent with the FW v2.3	Yunfeng Yuan

CTPM Application Note

Table of Contents

1	I ² C Interface	2
1.1	CTPM interface to Host	2
1.2	I ² C Read/Write Interface description	2
1.3	Interrupt signal from CTPM to Host	3
1.4	Wakeup signal from Host to CTPM	4
2	CTP Register Mapping	4
2.1	Operating Mode	4
2.1.1	<i>DEVICE_MODE</i>	9
2.1.2	<i>GEST_ID</i>	9
2.1.3	<i>TD_STATUS</i>	9
2.1.4	<i>TOUCHn_XH (n:1-10)</i>	10
2.1.5	<i>TOUCHn_XL (n:1-10)</i>	10
2.1.6	<i>TOUCHn_YH (n:1-10)</i>	10
2.1.7	<i>TOUCHn_YL (n:1-10)</i>	10
2.1.8	<i>TOUCHn_WEIGHT (n:1-10)</i>	11
2.1.9	<i>TOUCHn_MISC (n:1-10)</i>	11
2.1.10	<i>ID_G_THGROUP</i>	11
2.1.11	<i>ID_G_THPEAK</i>	11
2.1.12	<i>ID_G_THCAL</i>	11
2.1.13	<i>ID_G_THWATER</i>	11
2.1.14	<i>ID_G_THTEMP</i>	12
2.1.15	<i>ID_G_THDIFF</i>	12
2.1.16	<i>ID_G_CTRL</i>	12
2.1.17	<i>ID_G_TIMEENTERMONITOR</i>	12
2.1.18	<i>ID_G_PERIODACTIVE</i>	12
2.1.19	<i>ID_G_PERIODMONITOR</i>	12
2.1.20	<i>ID_G_LEFT_RIGHT_OFFSET</i>	13
2.1.21	<i>ID_G_UP_DOWN_OFFSET</i>	13
2.1.22	<i>ID_G_DISTANCE_LEFT_RIGHT</i>	13
2.1.23	<i>ID_G_DISTANCE_UP_DOWN</i>	13
2.1.24	<i>ID_G_RADIAN_VALUE</i>	13
2.1.25	<i>ID_G_ZOOM_DIS_SQR</i>	14
2.1.26	<i>ID_G_MAX_X_HIGH</i>	14
2.1.27	<i>ID_G_MAX_X_LOW</i>	14
2.1.28	<i>ID_G_MAX_Y_HIGH</i>	14
2.1.29	<i>ID_G_MAX_Y_LOW</i>	14
2.1.30	<i>ID_G_K_X_HIGH</i>	14
2.1.31	<i>ID_G_K_X_LOW</i>	15
2.1.32	<i>ID_G_K_Y_HIGH</i>	15
2.1.33	<i>ID_G_K_Y_LOW</i>	15
2.1.34	<i>ID_G_AUTO_CLB_MODE</i>	15
2.1.35	<i>ID_G_LIB_VERSION_H</i>	15
2.1.36	<i>ID_G_LIB_VERSION_L</i>	15

CTPM Application Note

2.1.37	<i>ID_G_CIPHER</i>	15
2.1.38	<i>ID_G_MODE</i>	16
2.1.39	<i>ID_G_PMODE</i>	16
2.1.40	<i>ID_G_FIRMWARE_ID</i>	16
2.1.41	<i>ID_G_STATE</i>	16
2.1.42	<i>ID_G_FT5201ID</i>	16
2.1.43	<i>ID_G_ERR</i>	16
2.1.44	<i>ID_G_CLB</i>	17
2.1.45	<i>ID_G_STATIC_TH</i>	17
2.1.46	<i>ID_G_MID_SPEED_TH</i>	17
2.1.47	<i>ID_G_HIGH_SPEED_TH</i>	17
2.1.48	<i>ID_G_DRAW_LINE_TH</i>	17
2.1.49	<i>ID_G_RELEASE_CODE_ID</i>	17
2.1.50	<i>ID_G_DRAW_LINE_TH</i>	18
2.1.51	<i>ID_G_RELEASE_CODE_ID</i>	18
2.2	Test Mode.....	18
2.2.1	<i>DEVICE_MODE</i>	19
2.2.2	<i>ROW_ADDR</i>	20
2.2.3	<i>ROWDATAN_H</i>	20
2.2.4	<i>ROWDATAN_L</i>	20
2.3	Test1 Mode(For big size only).....	21
2.3.1	<i>DEVICE_MODE</i>	22
2.3.2	<i>ROWDATA_n_H</i>	23
2.3.3	<i>ROWDATA_n_L</i>	23
2.4	System information Mode.....	24
2.4.1	<i>DEVICE_MODE</i>	25
2.4.2	<i>BIST_COMM</i>	25
2.4.3	<i>BIST_STAT</i>	25
2.4.4	<i>BL_VERH</i>	25
2.4.5	<i>BL_VERL</i>	26
2.4.6	<i>FTS_IC_VERH</i>	26
2.4.7	<i>FTS_IC_VERL</i>	26
2.4.8	<i>APP_IDH</i>	26
2.4.9	<i>APP_IDL</i>	27
2.4.10	<i>APP_VERH</i>	27
2.4.11	<i>APP_VERL</i>	27
2.4.12	<i>CID_n(n:0-4)</i>	27
3	CTPM Application Introduction.....	28
3.1	Standard Application information of FT5X06.....	28
3.1.1	<i>Standard application circuit of FT5206GE1</i>	28
3.1.2	<i>Standard application circuit of FT5306DE4</i>	29
3.1.3	<i>Standard application circuit of FT5206EE8</i>	30
4	Communication between host and CTPM.....	30
4.1	Communication Contents.....	30

CTPM Application Note

4.2 I2C Example Code	31
----------------------------	----

CTPM Application Note

Terminology

CTP – Capacitive touch panel

CTPM – Capacitive touch panel module

1 I²C Interface

1.1 CTPM interface to Host

Figure 1-1 shows how CTPM communicates with the Host, there are three kinds of communication between CTPM and Host, we will introduce each communication in this section.

1. Transfer the data via I²C
2. Send interrupt when there is a valid touch
3. Host send Wakeup signal to CTPM

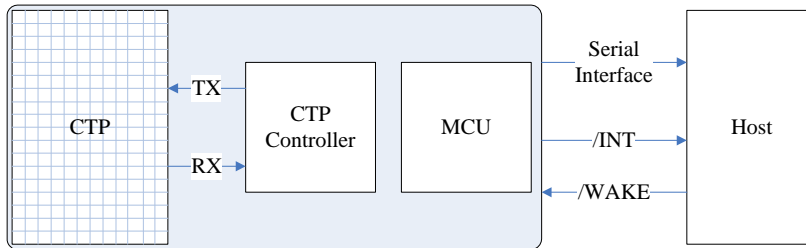

Figure 1-1 CTPM and Host connection

The Power Supply voltage of CTPM is 2.8V~3.3V, interface supply voltage is 2.8V~3.3V. There are Control Interface and Data Interface. As

Figure 1-1 demonstrates, Serial interface is the data interface, /INT and /WAKE are the control interface. For the detail, please refer to Table 1-1.

Table 1-1 Description for TP module and Host interface

Port Name	Voltage	Polar	Description
Serial interface	2.8~3.3V		Serial interface is for data transfer between Host and CTPM. CTPM support both I2C and SPI interface
/INT	2.8~3.3V	LOW	The interrupt from the CTPM to the Host
/WAKE*	2.8~3.3V	LOW	Wakeup signal from host to the CTPM

1.2 I²C Read/Write Interface description

Write N bytes to I2C slave

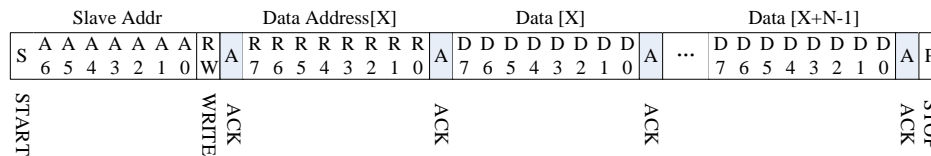

Set Data Address

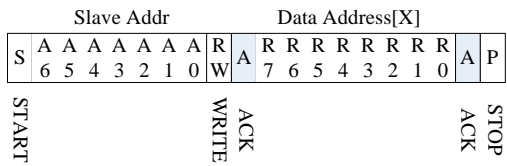

Read X bytes from I²C Slave

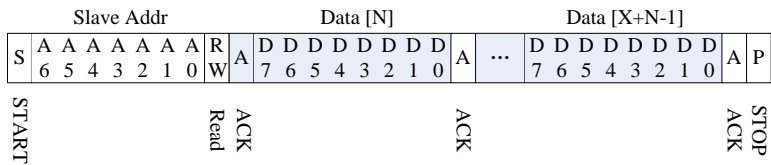

1.3 Interrupt signal from CTPM to Host

As for standard CTPM, the host need to use both interrupt control signal and serial data interface to get the touch data. There are two kinds of method to use interrupt signal: interrupt trigger and interrupt query.

Below is the timing diagram to get the touch data.

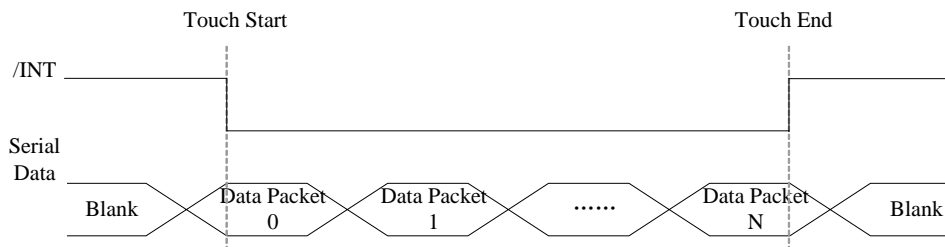

Figure 1-2 Interrupt query mode

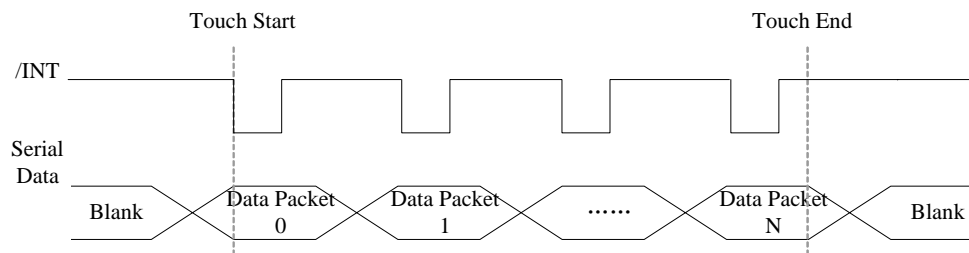

Figure 1-3 Interrupt trigger mode

The host use general I2C protocol to read the touch data or the information from CTPM . CTPM will send the host a interrupt signal when there is a valid touch. Then the host can use the serial data interface to get the touch data. If there is no valid touch detected, the /INT will not be pulled up, the host do not need to read the touch data.

NOTE: “valid touch” may have different definition in various systems. For example, in some systems, the valid touch is defined as there is one more valid touch point. But in some other systems, the valid touch is defined as one more valid touch with valid gestures. In usual, /INT will be pulled up when there is a valid touch point, and to be low when a touch finishes.

As for interrupt trigger mode, /INT signal will be low if there is no touch detected. But for per update of valid touch data, CTPM will produce a valid pulse for /INT signal, host can read the touch data periodically according

to the frequency of this pulse. In this mode, the pulse frequency is the touch data update frequency.

1.4 Wakeup signal from Host to CTPM

Host can use the Wakeup signal to wakeup the I²C slave device.

This pin should be connected to GND when flash programming while in normal running mode it should not be connected to GND.

2 CTP Register Mapping

This chapter describes the standard FTS Capacitive Touch Panel products communication registers in address order for each device mode. The most detailed descriptions of the Standard Products communication registers are in the Register Definitions section of each chapter. The device modes are listed in the table below, along with each mode's register prefix.

Device Mode	Prefix	Val	Description
Operating	Op	000b	Read touch point and gesture
Test0	Te	100b	Read raw data
Test1	T1e	101b	Read raw data(for big size only)
System Information	Sy	001b	Read system information related Reserved

2.1 Operating Mode

In this mode the CTP is fully functional as a touch screen controller. Read and write access address is just logical address which is not enforced by hardware or firmware. Here is the operating mode register map.

Operating Mode Register Map

Address	Name	Bit7	Bit6	Bit5	Bit4	Bit3	Bit2	Bit1	Bit0	Host Access
Op,00h	DEVIDE_MODE		Device Mode[2:0]							RW
Op,01h	GEST_ID	Gesture ID[7:0]								R
Op,02h	TD_STATUS	Frame remaining				Number of touch points[3:0]				R
Op,03h	TOUCH1_XH	1 st Event Flag				1 st Touch X Position[11:8]				R
Op,04h	TOUCH1_XL	1 st Touch X Position[7:0]								R
Op,05h	TOUCH1_YH	1 st Touch ID[3:0]				1 st Touch Y Position[11:8]				R
Op,06h	TOUCH1_YL	1 st Touch Y Position[7:0]								R
Op,07h	TOUCH1_WEIGHT	1 st Touch Weight[7:0]								R

CTPM Application Note

Op,08h	TOUCH1_MISC	1 st Touch Area[3:0]		1 st Touch Direction [1:0]	1 st Touch Speed [1:0]	R
Op,09h	TOUCH2_XH	2 nd Event Flag		2 nd Touch X Position[11:8]		R
Op,0Ah	TOUCH2_XL	2 nd touch X Position[7:0]				R
Op,0Bh	TOUCH2_YH	2 nd Touch ID[3:0]		2 nd Touch Y Position[11:8]		R
Op,0Ch	TOUCH2_YL	2 nd Touch Y Position[7:0]				R
Op,0Dh	TOUCH2_WEIGHT	2 nd Touch Weight[7:0]				R
Op,0Eh	TOUCH2_MISC	2 nd Touch Area[3:0]		2 nd Touch Direction [1:0]	2 nd Touch Speed [1:0]	R
Op,0Fh	TOUCH3_XH	3 rd Event Flag		3 rd Touch X Position[11:8]		R
Op,10h	TOUCH3_XL	3 rd Touch X Position[7:0]				R
Op,11h	TOUCH3_YH	3 rd Touch ID[3:0]		3 rd Touch Y Position[11:8]		R
Op,12h	TOUCH3_YL	3 rd Touch Y Position[7:0]				R
Op,13h	TOUCH3_WEIGHT	3 rd Touch Weight[7:0]				R
Op,14h	TOUCH3_MISC	3 rd Touch Area[3:0]		3 rd Touch Direction [1:0]	3 rd Touch Speed [1:0]	R
Op,15h	TOUCH4_XH	4 th Event Flag		4 th Touch X Position[11:8]		R
Op,16h	TOUCH4_XL	4 th Touch X Position[7:0]				R
Op,17h	TOUCH4_YH	4 th Touch ID[3:0]		4 th Touch Y Position[11:8]		R
Op,18h	TOUCH4_YL	4 th Touch Y Position[7:0]				R
Op,19h	TOUCH4_WEIGHT	4 th Touch Weight[7:0]				R
Op,1Ah	TOUCH4_MISC	4 th Touch Area[3:0]		4 th Touch Direction [1:0]	4 th Touch Speed [1:0]	R
Op,1Bh	TOUCH5_XH	5 th Event Flag		5 th Touch X Position[11:8]		R
Op,1Ch	TOUCH5_XL	5 th Touch X Position[7:0]				R
Op,1Dh	TOUCH5_YH	5 th Touch ID[3:0]		5 th Touch Y Position[11:8]		R
Op,1Eh	TOUCH5_YL	5 th Touch Y Position[7:0]				R

CTPM Application Note

Op,1Fh	TOUCH5_WEIGHT	5 th Touch Weight[7:0]			R
Op,20h	TOUCH5_MISC	5 th Touch Area[3:0]	5 th Touch Direction [1:0]	5 th Touch Speed [1:0]	R
Op,21h	TOUCH6_XH	6 th Event Flag	6 th Touch X Position[11:8]		R
Op,22h	TOUCH6_XL	6 th Touch X Position[7:0]			R
Op,23h	TOUCH6_YH	6 th Touch ID[3:0]	6 th Touch Y Position[11:8]		R
Op,24h	TOUCH6_YL	6 th Touch Y Position[7:0]			R
Op,25h	TOUCH6_WEIGHT	6 th Touch Weight[7:0]			R
Op,26h	TOUCH6_MISC	6 th Touch Area[3:0]	6 th Touch Direction [1:0]	6 th Touch Speed [1:0]	R
Op,27h	TOUCH7_XH	7 th Event Flag	7 th Touch X Position[11:8]		R
Op,28h	TOUCH7_XL	7 th Touch X Position[7:0]			R
Op,29h	TOUCH7_YH	7 th Touch ID[3:0]	7 th Touch Y Position[11:8]		R
Op,2Ah	TOUCH7_YL	7 th Touch Y Position[7:0]			R
Op,2Bh	TOUCH7_WEIGHT	7 th Touch Weight[7:0]			R
Op,2Ch	TOUCH7_MISC	7 th Touch Area[3:0]	7 th Touch Direction [1:0]	7 th Touch Speed [1:0]	R
Op,2Dh	TOUCH8_XH	8 th Event Flag	8 th Touch X Position[11:8]		R
Op,2Eh	TOUCH8_XL	8 th Touch X Position[7:0]			R
Op,2Fh	TOUCH8_YH	8 th Touch ID[3:0]	8 th Touch Y Position[11:8]		R
Op,30h	TOUCH8_YL	8 th Touch Y Position[7:0]			R
Op,31h	TOUCH8_WEIGHT	8 th Touch Weight[7:0]			R
Op,32h	TOUCH8_MISC	8 th Touch Area[3:0]	8 th Touch Direction [1:0]	8 th Touch Speed [1:0]	R
Op,33h	TOUCH9_XH	9 th Event Flag	9 th Touch X Position[11:8]		R
Op,34h	TOUCH9_XL	9 th Touch X Position[7:0]			R
Op,35h	TOUCH9_YH	9 th Touch ID[3:0]	9 th Touch Y Position[11:8]		R

CTPM Application Note

Op,36h	TOUCH9_YL	9 th Touch Y Position[7:0]			R
Op,37h	TOUCH9_WEIGHT	9 th Touch Weight[7:0]			R
Op,38h	TOUCH9_MISC	9 th Touch Area[3:0]	9 th Touch Direction [1:0]	9 th Touch Speed [1:0]	R
Op,39h	TOUCH10_XH	10 th Event Flag		10 th Touch X Position[11:8]	R
Op,3Ah	TOUCH10_XL	10 th Touch X Position[7:0]			R
Op,3Bh	TOUCH10_YH	10 th Touch ID[3:0]	10 th Touch Y Position[11:8]		R
Op,3Ch	TOUCH10_YL	10 th Touch Y Position[7:0]			R
Op,3Dh	TOUCH10_WEIGHT	10 th Touch Weight[7:0]			R
Op,3Eh	TOUCH10_MISC	10 th Touch Area[3:0]	10 th Touch Direction [1:0]	10 th Touch Speed [1:0]	R
Op,3Fh	Reserved				
...	...				
Op,7Fh	Reserved				
Op,80h	ID_G_THGROUP	valid touching detect threshold.			R/W
Op,81h	ID_G_THPEAK	valid touching peak detect threshold.			R/W
Op,82h	ID_G_THCAL	the threshold when calculating the focus of touching.			R/W
Op,83h	ID_G_THWATER	the threshold when there is surface water.			R/W
Op,84h	ID_G_THTEMP	the threshold of temperature compensation.			R/W
Op,85h	ID_G_THDIFF	the threshold whether the coordinate is different from the original			R/W
Op,86h	ID_G_CTRL		Power control mode[1:0]	R/W	
Op,87h	ID_G_TIME_ENTER_MONITOR	The timer of entering monitor status			R/W
Op,88h	ID_G_PERIODACTIVE		Period Active[3:0]	R/W	
Op,89h	ID_G_PERIODMONITOR	The timer of entering idle while in monitor status			R/W
Op,92h	ID_G_L_R_OFFSET	Maximum of the distance of X axis of the valid move up, move down gesture.			R/W
Op,93h	ID_G_U_D_OFFSET	Maximum of the distance of Y axis of the valid move left, move right gesture.			R/W
Op,94h	ID_G_DISTANCE_LEFT_RIGHT	Minimum of the distance of X axis of the valid move left, move right gesture.			R/W

CTPM Application Note

Op,95h	ID_G_DISTANCE_UP_DOWN	Minimum of the distance of Y axis of the valid move up, move down gesture.	R/W
Op,96h	ID_G_RADIAN_VALUE	Minmum of angle of Double Right/Left Rotation gesture	R/W
Op,97h	ID_G_ZOOM_DIS_SQR	The thereshold of valid Zoom In,Zoom Out gesture.	R/W
Op,98h	ID_G_MAX_X_HIGH	maximum resolution of X axis high byte	R/W
Op,99h	ID_G_MAX_X_LOW	maximum resolution of X axis low byte	R/W
Op,9Ah	ID_G_MAX_Y_HIGH	minimum resolution of Y axis high byte	R/W
Op,9Bh	ID_G_MAX_Y_LOW	minimum resolution of Y axis low byte	R/W
Op,9Ch	ID_G_K_X_HIGH	the resolution coefficient of X axis high byte	R/W
Op,9Dh	ID_G_K_X_LOW	the resolution coefficient of X axis low byte	R/W
Op,9Eh	ID_G_K_Y_HIGH	the resolution coefficient of Y axis high byte	R/W
Op,9Fh	ID_G_K_Y_LOW	the resolution coefficient of Y axis low byte	R/W
Op,A0h	ID_G_AUTO_CLB_MODE	auto calibration mode	R/W
Op,A1h	ID_G_LIB_VERSION_H	Firmware Library Version H byte	R
Op,A2h	ID_G_LIB_VERSION_L	Firmware Library Version L byte	R
Op,A3h	ID_G_CIPHER	Chip vendor ID	R
Op,A4h	ID_G_MODE	the interrupt status to host	R
Op,A5h	ID_G_PMODE	Power Consume Mode	
Op,A6h	ID_G_FIRMID	Firmware ID	R
Op,A7h	ID_G_STATE	Running State	
Op,A8h	ID_G_FT5201ID	CTPM Vendor ID	R
Op,A9h	ID_G_ERR	Error Code	R
Op,AAh	ID_G_CLB	Configure TP module during calibration in Test Mode	R/W
Op,ABh	ID_G_STATIC_TH	The threshold of touching static status	R/W
Op,ACH	ID_G_MID_SPEED_TH	The threshold of touching normal speed status	R/W
Op,ADh	ID_G_HIGH_SPEED_TH	The threshold of touching high speed status	R/W
Op,AEh	ID_G_DRAW_LINE_TH	T	R/W
Op,AFh			R/W
...	...		
Op,FDh	Reserved		
Op,FEh	LOG_MSG_CNT	The log MSG count	R

Op,FFh	LOG_CUR_CHA	Current character of log message, will point to the next character when one character is read.	R
--------	-------------	--	---

2.1.1 DEVICE_MODE

This register is the device mode register, configure it to determine the current mode of the chip.

Address	Bit Address	Register Name	Description
Op,00h	6:4	Device Mode [2:0]	000b Normal operating Mode 001b System Information Mode (Reserved) 100b Test Mode – read raw data (Reserved) 101b Test1 Mode–read raw data(Reserved, big size)

2.1.2 GEST_ID

This register describes the gesture of a valid touch.

Address	Bit Address	Register Name	Description
Op,01h	7:0	Gesture ID [7:0]	Gesture ID 0x10 Single Touch Pan North 0x14 Single Touch Pan East 0x18 Single Touch Pan South 0x1C Single Touch Pan West 0x20 Single Touch Single Click 0x22 Single Touch Double Click 0x28 Single Touch Rotate Clockwise 0x29 Single Touch rotate Counter Clockwise 0x48 Zoom In 0x49 Zoom Out 0x81 Double Left Rotate 0x82 Double Right Rotate 0x00 No Gesture

2.1.3 TD_STATUS

This register is the Touch Data status register.

Address	Bit Address	Register Name	Description
Op,02h	3:0	Number of touch points[3:0]	How many points detected. 1-5 is valid.
	7:4	Frame remaining [7:4]	Frame remaining after host's reading Range from 0 to 9

2.1.4 TOUCH_n_XH (n:1-10)

This register describes MSB of the X coordinate of the nth touch point and the corresponding event flag.

Address	Bit Address	Register Name	Description
Op,03h ~ Op,39h	7:6	Event Flag	00b: Put Down 01b: Put Up 10b: Contact 11b: Reserved
	5:4		Reserved
	3:0	Touch X Position [11:8]	MSB of Touch X Position in pixels

2.1.5 TOUCH_n_XL (n:1-10)

This register describes LSB of the X coordinate of the nth touch point.

Address	Bit Address	Register Name	Description
Op,04h ~ Op,3Ah	7:0	Touch X Position [7:0]	LSB of the Touch X Position in pixels

2.1.6 TOUCH_n_YH (n:1-10)

This register describes MSB of the Y coordinate of the nth touch point and corresponding touch ID.

Address	Bit Address	Register Name	Description
Op,05h ~ Op,3Bh	7:4	Touch ID[3:0]	Touch ID of Touch Point
	3:0	Touch X Position [11:8]	MSB of Touch Y Position in pixels

2.1.7 TOUCH_n_YL (n:1-10)

This register describes LSB of the Y coordinate of the nth touch point.

Address	Bit Address	Register Name	Description
Op,06h ~ Op,3Ch	7:0	Touch X Position [7:0]	LSB of The Touch Y Position in pixels

2.1.8 TOUCH_n_WEIGHT (n:1-10)

This register describes weight of the nth touch point.

Address	Bit Address	Register Name	Description
Op,07h	7:4	Touch Area[7:4]	The valid touching area
~ Op,3Dh	3:2	Touch Direction	0: up 1:down 2:left 3:right
	1:0	Touch Speed	0: static 1: normal speed 2: high speed

2.1.9 TOUCH_n_MISC (n:1-10)

This register describes the miscellaneous information of the nth touch point.

Address	Bit Address	Register Name	Description
Op,08h ~ Op,3Eh	7:0	Touch Weight[7:0]	Valid points in X direction×Valid points in Y direction/2

2.1.10 ID_G_THGROUP

This register describes valid touching detect threshold.

Address	Bit Address	Register Name	Description
Op,80h	7:0	ID_G_THGROUP	The actual value will be 4 times of the register's value. Default:180/4

2.1.11 ID_G_THPEAK

This register describes valid touching peak detect threshold.

Address	Bit Address	Register Name	Description
Op,81h	7:0	ID_G_THPEAK	Default:60

2.1.12 ID_G_THCAL

This register describes threshold when calculating the focus of touching.

Address	Bit Address	Register Name	Description
Op,82h	7:0	ID_G_THCAL	Default:16

2.1.13 ID_G_THWATER

This register describes threshold when there is surface water.

Address	Bit Address	Register Name	Description
Op,83h	7:0	ID_G_THWATER	Default:60

2.1.14 ID_G_THTEMP

This register describes threshold of temperature compensation.

Address	Bit Address	Register Name	Description
Op,84h	7:0	ID_G_THTEMP	The actual value must be 4 times of the register's value.Default:100

2.1.15 ID_G_THDIFF

This register describes threshold whether the coordinate is different from the original.

Address	Bit Address	Register Name	Description
Op,85h	7:0	ID_G_THDIFF	The actual value must be 16_ timers of the register's value. Default :160

2.1.16 ID_G_CTRL

This register describes the run mode of microcontroller controlled by host

Address	Bit Address	Register Name	Description
Op,86h	0	ID_G_CTRL	0: not auto jump 1:auto jump,default :1

2.1.17 ID_G_TIMEENTERMONITOR

This register describes the time delay value when entering monitor status.

Address	Bit Address	Register Name	Description
Op,87h	7:0	ID_G_TIME ENTERMONITOR	Default :200

2.1.18 ID_G_PERIODACTIVE

This register describes the period of active status, it should not less than 12

Address	Bit Address	Register Name	Description
Op,88h	4:0	ID_G_PERIOD ACTIVE	Range form 3 to 14,default 6
	7:4		

2.1.19 ID_G_PERIODMONITOR

This register describes period of monitor status, it should not less than 30.

Address	Bit Address	Register Name	Description
Op,89h	7:0	ID_G_PERIOD MONITOR	Default:40

2.1.20 ID_G_LEFT_RIGHT_OFFSET

This register is only used in the mode of continuous reporting gesture to host while valid gesture produced.

Address	Bit Address	Register Name	Description
Op,92h	7:0	ID_G_LEFT_RIGHT_OFFSET	The maximum distance on X axis to produce Up, Down gesture. Default: 50

2.1.21 ID_G_UP_DOWN_OFFSET

This register is only used in the mode of continuous reporting gesture to host while valid gesture produced.

Address	Bit Address	Register Name	Description
Op,93h	7:0	ID_G_UP_DOWN_OFFSET	The maximum distance on Y axis to produce Left, Right gesture. Default:50

2.1.22 ID_G_DISTANCE_LEFT_RIGHT

This register is only used in the mode of continuous reporting gesture to host while valid gesture produced.

Address	Bit Address	Register Name	Description
Op,94h	7:0	ID_G_DISTANCE_LEFT_RIGHT	The minimum distance on X axis to produce Left, Right gesture. Default: 50

2.1.23 ID_G_DISTANCE_UP_DOWN

This register is only used in the mode of continuous reporting gesture to host while valid gesture produced.

Address	Bit Address	Register Name	Description
Op,95h	7:0	ID_G_DISTANCE_UP_DOWN	The minimum distance on Yaxis to produce Up, Down gesture. Default: 50

2.1.24 ID_G_RADIAN_VALUE

This register is only used in the mode of continuous reporting gesture to host while valid gesture

produced.

Address	Bit Address	Register Name	Description
Op,96h	7:0	ID_G_ RADIANT_VALUE	The minimum angle to produce Double Left or Right Rotation.

2.1.25 ID_G_ZOOM_DIS_SQR

This register describes minimum square of distance while zoom in or out used in both reporting mode.

Address	Bit Address	Register Name	Description
Op,97h	7:0	ID_G_ ZOOM_DIS_SQR	The minimum distance to produce Zoom In or Out used in both reporting mode.Default:50

2.1.26 ID_G_MAX_X_HIGH

This register describes the resolution of X axis high byte.

Address	Bit Address	Register Name	Description
Op, 98h	7:0	ID_G_MAX_X_HIGH	MSB of the resolution of X axis.

2.1.27 ID_G_MAX_X_LOW

This register describes the resolution of X axis low byte.

Address	Bit Address	Register Name	Description
Op, 99h	7:0	ID_G_MAX_X_LOW	LSB of the resolution of X axis.

2.1.28 ID_G_MAX_Y_HIGH

This register describes the resolution of Y axis high byte.

Address	Bit Address	Register Name	Description
Op,9Ah	7:0	ID_G_MAX_Y_HIGH	MSB of the resolution of Y axis.

2.1.29 ID_G_MAX_Y_LOW

This register describes the resolution of Y axis low byte.

Address	Bit Address	Register Name	Description
Op, 9Bh	7:0	ID_G_MAX_Y_LOW	LSB of the resolution of Y axis.

2.1.30 ID_G_K_X_HIGH

This register describes the resolution coefficient of X axis high byte.

Address	Bit Address	Register Name	Description
Op, 9Ch	7:0	ID_G_K_X_HIGH	MSB of the resolution coefficient of X axis

2.1.31 ID_G_K_X_LOW

This register describes the resolution coefficient of X axis low byte..

Address	Bit Address	Register Name	Description
Op, 9Dh	7:0	ID_G_K_X_LOW	LSB of the resolution coefficient of X axis

2.1.32 ID_G_K_Y_HIGH

This register describes the resolution coefficient of Y axis high byte.

Address	Bit Address	Register Name	Description
Op, 9Eh	7:0	ID_G_K_Y_HIGH	MSB of the resolution coefficient of Y axis

2.1.33 ID_G_K_Y_LOW

This register describes the resolution coefficient of Y axis low byte.

Address	Bit Address	Register Name	Description
Op, 9Fh	7:0	ID_G_K_Y_LOW	LSB of the resolution coefficient of Y axis

2.1.34 ID_G_AUTO_CLB_MODE

This register describes auto calibration mode.

Address	Bit Address	Register Name	Description
Op, A0h	7:0	ID_G_AUTO_CLB_MODE	8'h 00: enable auto calibration 8'h ff: disable auto calibration Default:8'hff

2.1.35 ID_G_LIB_VERSION_H

This register describes library version high byte.

Address	Bit Address	Register Name	Description
Op, A1h	7:0	ID_G_LIB_VERSION_H	R: xx

2.1.36 ID_G_LIB_VERSION_L

This register describes library version low byte.

Address	Bit Address	Register Name	Description
Op, A2h	7:0	ID_G_LIB_VERSION_L	R: xx

2.1.37 ID_G_CIPHER

This register describes vendor's chip id.

Address	Bit Address	Register Name	Description
OP, A3h	7:0	ID_G_CIPHER	R: 8h'55

2.1.38 ID_G_MODE

This register describes the interrupt status to host.

Address	Bit Address	Register Name	Description
Op,A4h	7:0	ID_G_MODE	0: enable interrupt to host 1: disable interrupt to host

2.1.39 ID_G_PMODE

This register describes the power consumption mode of the TPM when in running status.

Address	Bit Address	Register Name	Description
Op,A5h	7:0	ID_G_PMODE	0: active 1: monitor 3: hibernate(deep sleep)

2.1.40 ID_G_FIRMWARE_ID

This register describes the firmware id of the application.

Address	Bit Address	Register Name	Description
Op,A6h	7:0	ID_G_FIRMWARE_ID	R: 8'h05

2.1.41 ID_G_STATE

This register is used to configure the run mode of TPM.

Address	Bit Address	Register Name	Description
Op,A7h	7:0	ID_G_STATE	0: configure 1: work 2: calibration 3: factory 4: auto calibration Default:1

2.1.42 ID_G_FT5201ID

This register describes vendor's chip id

Address	Bit Address	Register Name	Description
Op,A8h	7:0	ID_G_FT5201ID	R: 8'h79

2.1.43 ID_G_ERR

This register describes the error code when the TPM is running.

Address	Bit Address	Register Name	Description
Op,A9h	7:0	ID_G_ERR	ERR Code 8'h00:OK

			8'h03:chip register writing inconsistent with reading 8'h05:chip start fail 8'h1A:no match among the basic input(such as TX_ORDER) while calibration Default:8'h00
--	--	--	---

2.1.44 ID_G_CLB

This register is used to configure the TPM when Calibration

Address	Bit Address	Register Name	Description
Op,AAh	7:0	ID_G_CLB	Mapping the Array of G_Bank1, total length is NUM_TX+NUM_RX+1. the array address increases 1 after every write. Default:8h'00

2.1.45 ID_G_STATIC_TH

This register is used to set the threshold of low speed of the moving point

Address	Bit Address	Register Name	Description
Op,ABh	7:0	ID_G_STATIC_TH	Default:8h'01

2.1.46 ID_G_MID_SPEED_TH

This register is used to set the threshold of mid speed of the moving point

Address	Bit Address	Register Name	Description
Op,ACH	7:0	ID_G_MID_SPEED_TH	Default:8h'02

2.1.47 ID_G_HIGH_SPEED_TH

This register is used to set the threshold of high speed of the moving point

Address	Bit Address	Register Name	Description
Op,ADh	7:0	ID_G_HIGH_SPEED_TH	Default:8h'04

2.1.48 ID_G_DRAW_LINE_TH

This register is used to set the maximum distance threshold of two points when drawing a line

Address	Bit Address	Register Name	Description
Op,AEh	7:0	ID_G_MID_SPEED_TH	Default:200

2.1.49 ID_G_RELEASE_CODE_ID

This register is used to set the firmware version except the library

Address	Bit Address	Register Name	Description
Op,AFh	7:0	ID_G_MID_SPEED_TH	Default:01

2.1.50 ID_G_DRAW_LINE_TH

This register is used to set the maximum distance threshold of two points when drawing a line

Address	Bit Address	Register Name	Description
Op,B0h	7:0	ID_G_MID_SPEED_TH	Default:200

2.1.51 ID_G_RELEASE_CODE_ID

This register is used to set the maximum distance threshold of two points when drawing a line

Address	Bit Address	Register Name	Description
Op,B1h	7:0	ID_G_MID_SPEED_TH	Default:200

2.2 Test Mode

In this mode, CTP will provide some panel related information. Host can get the following information in this mode

Raw data of touch panel

Panel configure related information

Test Mode Register Map

Address	Name	Bit7	Bit6	Bit5	Bit4	Bit3	Bit2	Bit1	Bit0	Host Access	
Te,00h	DEVIDE_MODE	Data Read Toggle	Device Mode[2:0]							RW	
Te,01h	ROW_ADDR	The address of the row to be read								RW	
Te,02h	START_SCAN	Start the scan command, the value stands for the scan frequency, will be set to zero when scan finishes									RW
Te,03h	ROW_NUM	Panel row number								RW	
Te,04h	COL_NUM	Panel column number								RW	
Te,05h	DRIVER_VOL	Driver voltage of chip								RW	
Te,06h	START_RX	Setting the RX start number								RW	
Te,07h	GAIN	Control the difference value for touching								RW	
Te,08h	ORIGIN_XH	High byte of origin X coordinate								RW	
Te,09h	ORIGIN_XL	Low byte of origin X coordinate								RW	
Te,0Ah	ORIGIN_YH	High byte of origin Y coordinate								RW	
Te,0Bh	ORIGIN_YL	Low byte of origin Y coordinate								RW	
Te,0Ch	RES_WH	High byte of width of resolution								RW	
Te,0Dh	RES_WL	Low byte of width of resolution								RW	
Te,0Eh	RES_HH	High byte of height of resolution								RW	
Te,0Fh	RES_HL	Low byte of height of resolution								RW	
Te,10h	RAWDATA0_H	High byte of raw data 0								R	

Te,11h	RAWDATA0_L	Low byte of raw data 0		R
Te,12h	RAWDATA1_H	High byte of raw data 1		R
Te,13h	RAWDATA1_L	Low byte of raw data 1		R
...		
Te,4Ah	RAWDATA29_H	High byte of raw data 29		R
Te,4Bh	RAWDATA29_L	Low byte of raw data 29		R
Te,4Ch	TH_POINT_NUM	Touch point number support		RW
Te,4Dh	Reserved			
Te,4Eh	Reserved			
Te,4Fh	Reserved			
Te,50h	TX_ORDER_0	TX Order, start from zero		RW
Te,51h	TX_ORDER_1			RW
...		RW
Te,77h	TX_ORDER_39			RW
Te,78h	ROW0_CAC	Charge Amplifier feedback Capacitance of ROW0		RW
Te,79h	ROW1_CAC	Charge Amplifier feedback Capacitance of ROW1		RW
...		
Te,9Fh	ROW39_CAC	Charge Amplifier feedback Capacitance of ROW39		RW
Te,A0h	COL0_CAC	Charge Amplifier feedback Capacitance of COL0		RW
...		
Te,BEh	COL29_CAC	Charge Amplifier feedback Capacitance of COL29		RW
Te,BFh	ROW0_1_OFFSET	Offset of ROW1	Offset of ROW0	RW
...	
Te,D2h	ROW38_39_OFFSET	Offset of ROW39	Offset of ROW38	RW
Te,D3h	COL0_1_OFFSET	Offset of COL1	Offset of COL0	RW
...	
Te,E1h	COL28_29_OFFSET	Offset of COL29	Offset of COL28	RW
...	...			
Te,FEh	LOG_MSG_CNT	The log MSG count		R
Te,FFh	LOG_CUR_CHA	Current character of log message, will point to the next character when one character is read.		R

2.2.1 DEVICE_MODE

This register is the device mode register, configure it to determine the current mode of the chip.

Address	Bit Address	Register Name	Description
---------	-------------	---------------	-------------

Te,00h	7	Data Read Toggle	This bit is toggled by the Host only when a data transfer between the Host and TrueTouch device requires register based handshaking.
	6:4	Device Mode[2:0]	000b Normal operating Mode 001b System Information Mode (Reserved) 100b Test Mode – read raw data (Reserved) 101b Test1 Mode–read raw data(Reserved, big size)

2.2.2 ROW_ADDR

This register is the Touch Data status register.

Address	Bit Address	Register Name	Description
Te,01h	7:0	Row address	The address of the row to be read Please delay for more than 100us, then read the raw data

2.2.3 ROWDATAN_H

This register is the Touch Data status register.

Address	Bit Address	Register Name	Description
Te,(10+2n)h	7:0	High byte of raw data N	High byte of raw data N If N exceeds the column number will return 0xff

2.2.4 ROWDATAN_L

This register is the Touch Data status register.

Address	Bit Address	Register Name	Description
Te,(10+2n+1)h	7:0	Low byte of raw data N	Low byte of raw data N If N exceeds the column number will return 0xff

2.3 Test1 Mode(For big size only)

In this mode, CTP will provide some panel related information. Host can get the following information in this mode

Raw data of touch panel

Panel configure related information

Test Mode Register Map

Address	Name	Bit7	Bit6	Bit5	Bit4	Bit3	Bit2	Bit1	Bit0	Host Access
T1e,00h	DEVIDE_MODE	Data Read Toggle	Device Mode[2:0]							RW
T1e,01h	Reserved	Reserved								RW
T1e,02h	Reserved	Reserved								RW
T1e,03h	Reserved	Reserved								RW
T1e,04h	Reserved	Reserved								RW
T1e,05h	Reserved	Reserved								RW
T1e,06h	Reserved	Reserved								RW
T1e,07h	Reserved	Reserved								RW
T1e,08h	Reserved	Reserved								RW
T1e,09h	Reserved	Reserved								RW
T1e,0Ah	Reserved	Reserved								RW
T1e,0Bh	Reserved	Reserved								RW
T1e,0Ch	Reserved	Reserved								RW
T1e,0Dh	Reserved	Reserved								RW
T1e,0Eh	Reserved	Reserved								RW
T1e,0Fh	Reserved	Reserved								RW
T1e,10h	RAWDATA30_H	High byte of raw data 30								R
T1e,11h	RAWDATA30_L	Low byte of raw data 30								R
T1e,12h	RAWDATA31_H	High byte of raw data 31								R
T1e,13h	RAWDATA31_L	Low byte of raw data 31								R
...								
T1e,4Ah	RAWDATA59_H	High byte of raw data 59								R
T1e,4Bh	RAWDATA59_L	Low byte of raw data 59								R
T1e,4Ch	TH_POINT_NUM	Touch point number support								RW
T1e,4Dh	Reserved									
T1e,4Eh	Reserved									
T1e,4Fh	Reserved									

T1e,50h	TX_ORDER_40	TX Order, start from zero		RW
T1e,51h	TX_ORDER_41			RW
...		RW
T1e,77h	TX_ORDER_79			RW
T1e,78h	ROW40_CAC	Charge Amplifier feedback Capacitance of ROW40		RW
T1e,79h	ROW41_CAC	Charge Amplifier feedback Capacitance of ROW41		RW
...		
T1e,9Fh	ROW79_CAC	Charge Amplifier feedback Capacitance of ROW79		RW
T1e,A0h	COL30_CAC	Charge Amplifier feedback Capacitance of COL30		RW
...		
T1e,BEh	COL59_CAC	Charge Amplifier feedback Capacitance of COL59		RW
T1e,BFh	ROW40_41_OFFSET	Offset of ROW41	Offset of ROW40	RW
...	
T1e,D2h	ROW78_79_OFFSET	Offset of ROW79	Offset of ROW78	RW
T1e,D3h	COL30_31_OFFSET	Offset of COL31	Offset of COL30	RW
...	
T1e,E1h	COL58_59_OFFSET	Offset of COL59	Offset of COL58	RW
...	...			
T1e,FEh	LOG_MSG_CNT	The log MSG count		R
T1e,FFh	LOG_CUR_CHA	Current character of log message, will point to the next character when one character is read.		R

2.3.1 DEVICE_MODE

This register is the device mode register, configure it to determine the current mode of the chip.

Address	Bit Address	Register Name	Description
T1e,00h	7	Data Read Toggle	This bit is toggled by the Host only when a data transfer between the Host and TrueTouch device requires register based handshaking.
	6:4	Device Mode[2:0]	000b Normal operating Mode 001b System Information Mode (Reserved) 100b Test Mode – read raw data (Reserved) 101b Test1 Mode – read raw data(Big Size) (Reserved)

2.3.2 ROWDATAn_H

This register is the Touch Data status register.

Address	Bit Address	Register Name	Description
T1e,(10+2n)h	7:0	High byte of raw data N	High byte of raw data N If N exceeds the column number will return 0xff

2.3.3 ROWDATAn_L

This register is the Touch Data status register.

Address	Bit Address	Register Name	Description
T1e,(10+2n+1)h	7:0	Low byte of raw data N	Low byte of raw data N If N exceeds the column number will return 0xff

2.4 System information Mode

This mode provides access to all of the one-time system information. The system information is either written by the host to permanently configure the device (for example, power timers), or is written to the device at compile time for the host to read (for example, application version). To enter BIST (built in self test) mode write the BIST command required into the BIST_COMM register.

Read and write access is theoretical and is not enforced by hardware or firmware. Words have their MSB at lower address.

System Information Mode Register Map

Address	Name	Bit7	Bit6	Bit5	Bit4	Bit3	Bit2	Bit1	Bit0	Host Access
Sy,00h	DEVIDE_MODE	Data Read Toggle	Device Mode[2:0]							RW
Sy,01h	BIST_COMM	BIST Command[7:0]								W
Sy,02h	BIST_STAT	BIST Status[7:0]								R
Sy,03h	Unused									
Sy,04h	Unused									
Sy,05h	Unused									
Sy,06h	Unused									
Sy,07h	UID_0	Unique Silicon ID #0[7:0]								R
Sy,08h	UID_1	Unique Silicon ID #1[7:0]								R
Sy,09h	UID_2	Unique Silicon ID #2[7:0]								R
Sy,0Ah	UID_3	Unique Silicon ID #3[7:0]								R
Sy,0Bh	UID_4	Unique Silicon ID #4[7:0]								R
Sy,0Ch	UID_5	Unique Silicon ID #5[7:0]								R
Sy,0Dh	UID_6	Unique Silicon ID #6[7:0]								R
Sy,0Eh	UID_7	Unique Silicon ID #7[7:0]								R
Sy,0Fh	BL_VERH	Bootloader version[15:8]								R
Sy,10h	BL_VERL	Bootloader version[7:0]								R
Sy,11h	FTS_IC_VERH	Focal Tech IC Version[15:8]								R
Sy,12h	FTS_IC_VERL	Focal Tech IC Version[7:0]								R
Sy,13h	APP_IDH	Application ID[15:8]								R
Sy,14h	APP_IDL	Application ID[7:0]								R
Sy,15h	APP_VERH	Application Version[15:8]								R
Sy,16h	APP_VERL	Application Version[7:0]								R
Sy,17h	Unused									

Sy,18h	Unused		
Sy,19h	Unused		
Sy,1Ah	Unused		
Sy,1Bh	CID_0	Custom ID #0[0:7]	R
Sy,1Ch	CID_1	Custom ID #1[0:7]	R
Sy,1Dh	CID_2	Custom ID #2[0:7]	R
Sy,1Eh	CID_3	Custom ID #3[0:7]	R
Sy,1Fh	CID_4	Custom ID #4[0:7]	R
...	...		
Sy,FEh	LOG_MSG_CNT	The log MSG count	R
Sy,FFh	LOG_CUR_CHA	Current character of log message, will point to the next character when one character is read.	R

2.4.1 DEVICE_MODE

This register is the device mode register, configure it to determine the current mode of the chip.

Address	Bit Address	Register Name	Description
Sy,00h	6:4	Device Mode[2:0]	000b Normal operating Mode 001b System Information Mode (Reserved) 100b Test Mode – read raw data (Reserved) 101b Test1 Mode – read raw data(Big Size,Reserved)

2.4.2 BIST_COMM

This register is the BIST command register. The BIST (built in self test) function to perform is set here.

Address	Bit Address	Register Name	Description
Sy,01h	7:0	BIST Command[7:0]	BIST command to perform.

2.4.3 BIST_STAT

This register reports the status of BIST (built in self test) functions either in progress or the last function completed.

Address	Bit Address	Register Name	Description
Sy,02h	7:0	BIST Command[7:0]	Status of the last BIST function started.

2.4.4 BL_VERH

This register contains the MSB of the bootloader version specified by the application.

Address	Bit Address	Register Name	Description

Sy,0Fh	7:0	Bootloader version[15:8]	R:xx
--------	-----	--------------------------	------

2.4.5 BL_VERL

This register contains the LSB of the bootloader version specified by the application.

Address	Bit Address	Register Name	Description
Sy,10h	7:0	Bootloader version[7:0]	R:xx.

2.4.6 FTS_IC_VERH

This is the FTS IC version register. This register contains the MSB of the FTS IC version. The value is BCD value, for example

- FT5201 – FTS_IC_VERH(0x52), FTS_IC_VERL(0x01)
- FT5202 – FTS_IC_VERH(0x52), FTS_IC_VERL(0x02)
- FT5206 – FTS_IC_VERH(0x52), FTS_IC_VERL(0x06)
- FT5306 – FTS_IC_VERH(0x53), FTS_IC_VERL(0x06)
- FT5406 – FTS_IC_VERH(0x54), FTS_IC_VERL(0x06)

Address	Bit Address	Register Name	Description
Sy,11h	7:0	Focal Tech IC version [15:8]	Focal Tech IC Version MSB

2.4.7 FTS_IC_VERL

This is the FTS IC version register. This register contains the MSB of the FTS IC version. The value is BCD value, for example

- FT5201 – FTS_IC_VERH(0x52), FTS_IC_VERL(0x01)
- FT5202 – FTS_IC_VERH(0x52), FTS_IC_VERL(0x02)
- FT5206 – FTS_IC_VERH(0x52), FTS_IC_VERL(0x06)
- FT5306 – FTS_IC_VERH(0x53), FTS_IC_VERL(0x06)
- FT5406 – FTS_IC_VERH(0x54), FTS_IC_VERL(0x06)

Address	Bit Address	Register Name	Description
Sy,12h	7:0	Focal Tech IC version [7:0]	Focal Tech IC Version LSB

2.4.8 APP_IDH

This is the application ID register. This register contains the MSB of the application ID. This value is set to designate the individual project.

Address	Bit Address	Register Name	Description
Sy,13h	7:0	Application Version [15:8]	R:xx

2.4.9 APP_IDL

This is the application ID register. This register contains the MSB of the application ID. This value is set to designate the individual project.

Address	Bit Address	Register Name	Description
Sy,14h	7:0	Application Version [15:8]	R:xx

2.4.10 APP_VERH

This is the application version register. This register contains the MSB of the application version. This value should be incremented on each internal or external release of the project.

Address	Bit Address	Register Name	Description
Sy,15h	7:0	Application Version [15:8]	R:xx

2.4.11 APP_VERL

This is the application version register. This register contains the LSB of the application version. This value should be incremented on each internal or external release of the project.

Address	Bit Addr.	Reg. Name	Description
Sy,16h	7:0	Application Version [7:0]	R:xx

2.4.12 CID_n(n:0-4)

These are Custom ID registers. These registers contain user defined Custom ID identifiers for the FT TPM.

Address	Bit Addr.	Reg. Name	Description
Sy,1Bh~1Fh	7:0	Application Version [7:0]	R:xx

3 CTPM Application Introduction

3.1 Standard Application information of FT5X06

Figure3-1,Figure3-2,Figure3-3 demonstrate the typical FT5x06 application schematic. It consists of FT's Capacitive Touch Panel(CTP), FT5X06 chip, and some peripheral components. According to the size of CTPM, you can choose the numbers of TX and RX needed.

3.1.1 Standard application circuit of FT5206GE1

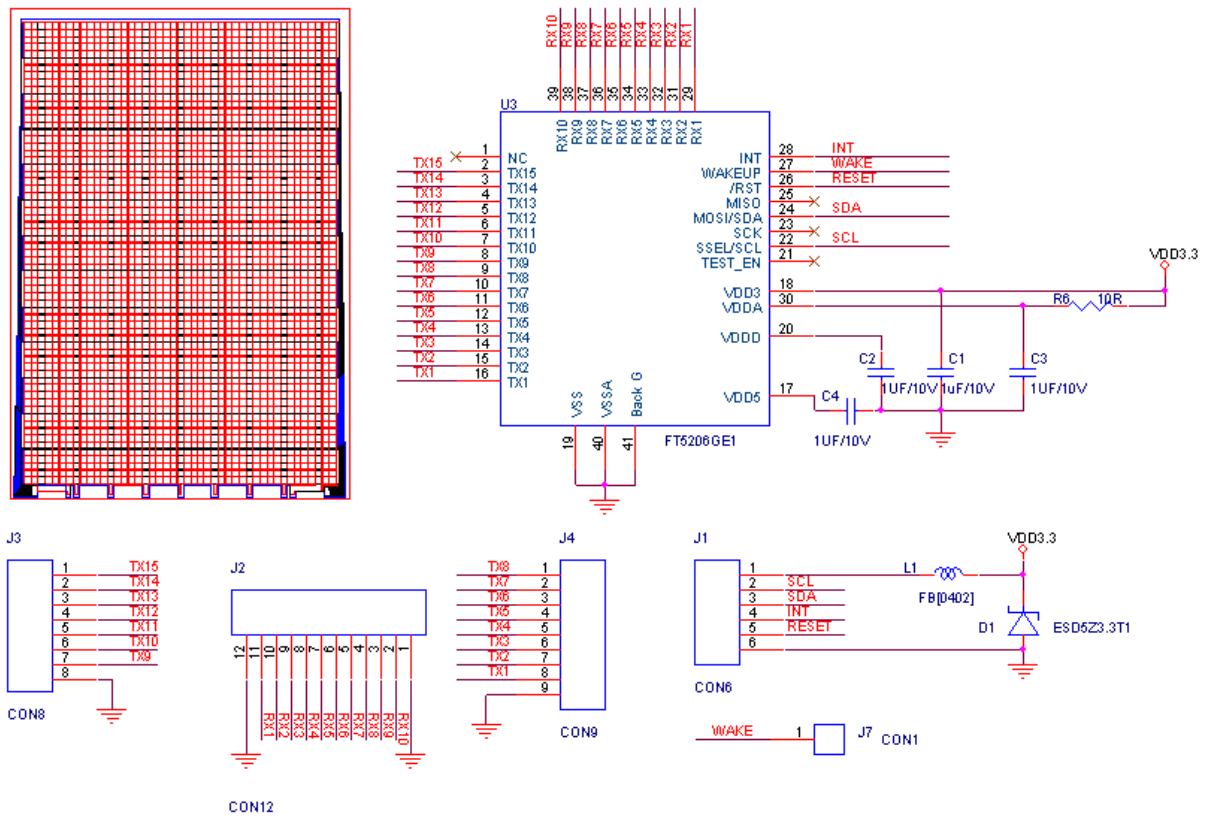

Figure 3-1 FT5206GE1 typical application schematic

3.1.2 Standard application circuit of FT5306DE4

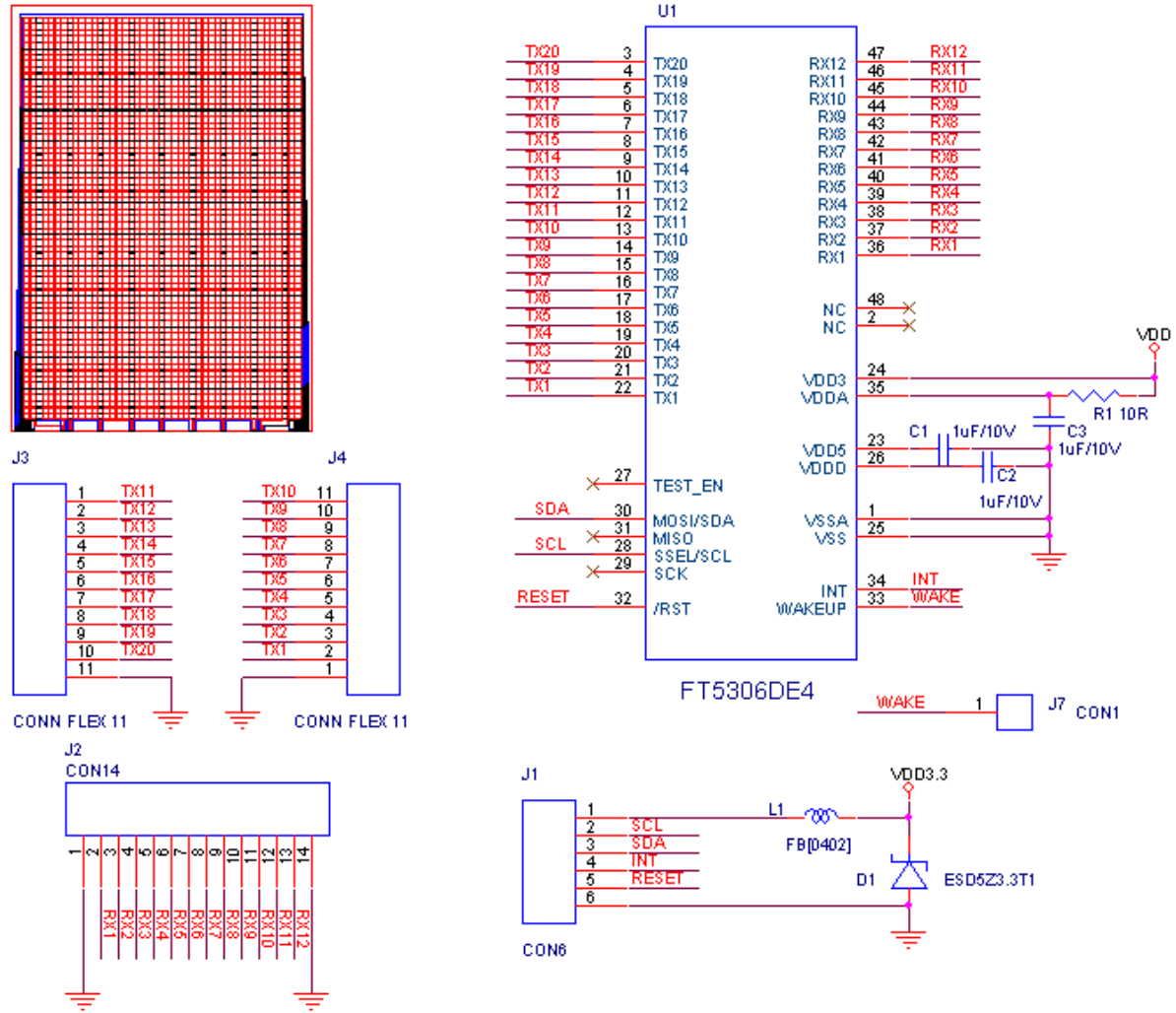

Figure 3-2 FT5306DE4 typical application schematic

3.1.3 Standard application circuit of FT5206EE8

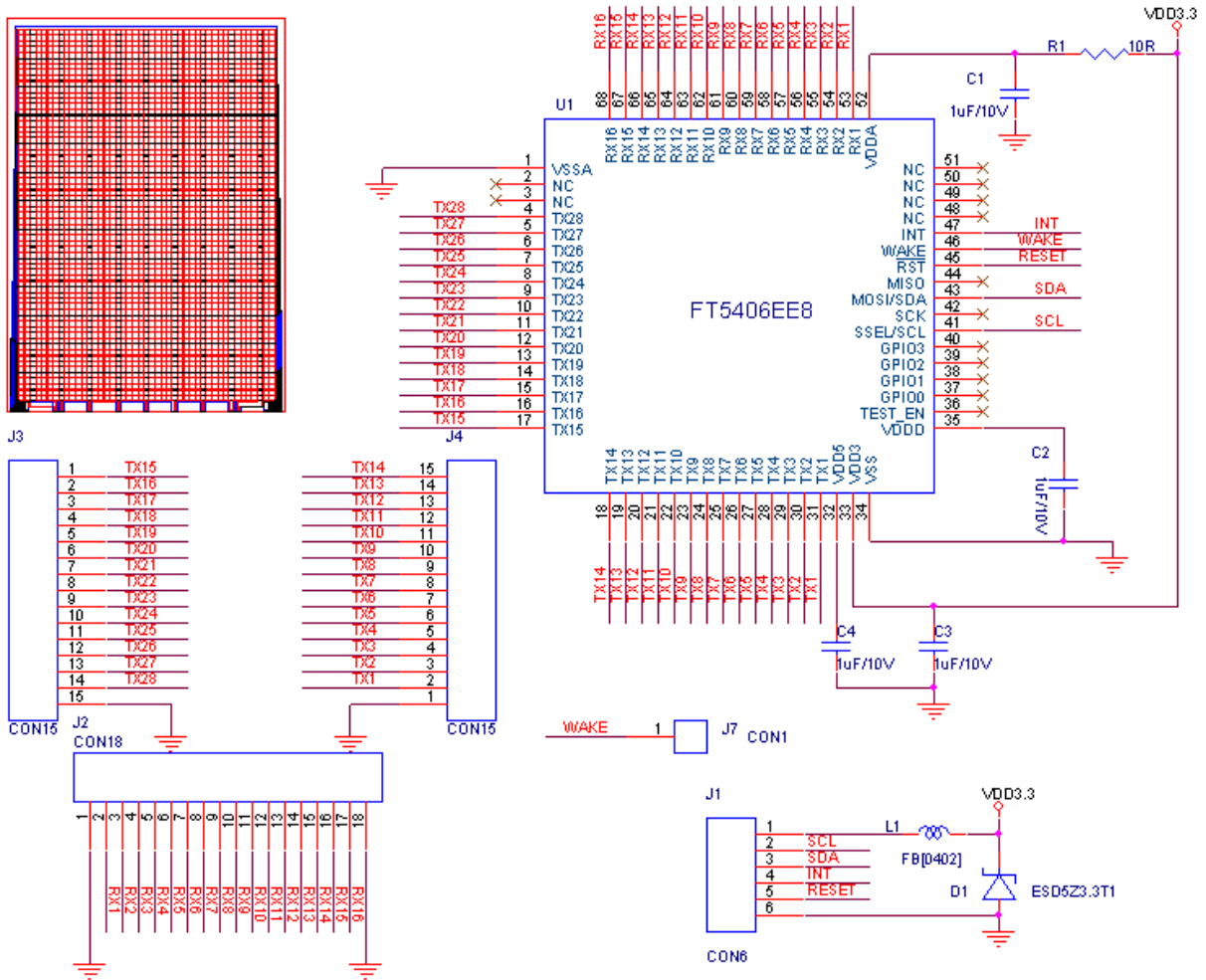

Figure 3-3 FT5406EE8 typical application schematic

4 Communication between host and CTPM

4.1 Communication Contents

The data Host received from the CTPM through serial interface are different depend on the configuration in Device Mode Register of the CTPM. Please refer to Section 2---CTP Register Mapping.

4.2 I2C Example Code

```

////////////////////////////////////
// I2C write bytes to device.
//
// Arguments: ucSlaveAdr - slave address
//            ucSubAdr - sub address
//            pBuf - pointer of buffer
//            ucBufLen - length of buffer
////////////////////////////////////
void i2cBurstWriteBytes(BYTE ucSlaveAdr, BYTE ucSubAdr, BYTE *pBuf, BYTE ucBufLen)
{
    BYTE ucDummy; // loop dummy
    ucDummy = I2C_ACCESS_DUMMY_TIME;
    while(ucDummy--)
    {
        if (i2c_AccessStart(ucSlaveAdr, I2C_WRITE) == FALSE)
            continue;
        if (i2c_SendByte(ucSubAdr) == I2C_NON_ACKNOWLEDGE) // check non-acknowledge
            continue;
        while(ucBufLen--) // loop of writing data
        {
            i2c_SendByte(*pBuf); // send byte
            pBuf++; // next byte pointer
        } // while
        break;
    } // while
    i2c_Stop();
}

////////////////////////////////////
// I2C read bytes from device.
//
// Arguments: ucSlaveAdr - slave address
//            ucSubAdr - sub address
//            pBuf - pointer of buffer
//            ucBufLen - length of buffer
////////////////////////////////////
void i2cBurstReadBytes(BYTE ucSlaveAdr, BYTE ucSubAdr, BYTE *pBuf, BYTE ucBufLen)
{
    BYTE ucDummy; // loop dummy

    ucDummy = I2C_ACCESS_DUMMY_TIME;

```

```

while(ucDummy--)
{
    if (i2c_AccessStart(ucSlaveAdr, I2C_WRITE) == FALSE)
        continue;
    if (i2c_SendByte(ucSubAdr) == I2C_NON_ACKNOWLEDGE) // check non-acknowledge
        continue;
    if (i2c_AccessStart(ucSlaveAdr, I2C_READ) == FALSE)
        continue;
    while(ucBufLen--) // loop to burst read
    {
        *pBuf = i2c_ReceiveByte(ucBufLen); // receive byte
        pBuf++; // next byte pointer
    } // while
    break;
} // while
i2c_Stop();
}

////////////////////////////////////
// I2C read current bytes from device.
//
// Arguments: ucSlaveAdr - slave address
//            pBuf - pointer of buffer
//            ucBufLen - length of buffer
////////////////////////////////////
void i2cBurstCurrentBytes(BYTE ucSlaveAdr, BYTE *pBuf, BYTE ucBufLen)
{
    BYTE ucDummy; // loop dummy

    ucDummy = I2C_ACCESS_DUMMY_TIME;
    while(ucDummy--)
    {
        if (i2c_AccessStart(ucSlaveAdr, I2C_READ) == FALSE)
            continue;
        while(ucBufLen--) // loop to burst read
        {
            *pBuf = i2c_ReceiveByte(ucBufLen); // receive byte
            pBuf++; // next byte pointer
        } // while
        break;
    } // while
    i2c_Stop();
}

```